

Service Experience

MAN B&W Two-stroke Diesel Engines

Engineering the Future – since 1758.

MAN Diesel & Turbo



Two-Stroke Service Experience

Introduction	5
Piston Ring Development	5
Cold Corrosion Control.....	7
Cylinder Lubrication – The Near Future	11
Crosshead Bearing Design for S and G-Type Engines (Mark 9 & 10).....	13
Main Bearings	15
Engine and Ship Acceleration Issues	16
Variable Exhaust Valve Timing on ME-B Engines	20
ME-B9.3 Inductive Sensors	22
G & S50ME-B9.3 Timing Unit Piston Design Modification	23
Multi-Purpose Controller (MPC) Quality Issue	23
System Oil Cleanliness on ME-C/ME-B Engines.....	26
Tier III Service and Test Experience.....	28
ME-GI Service Experience	31
Conclusion.....	33

Introduction

A high number of G-type and S-type engines of the latest generation have entered service successfully. These engines are generally characterised by Tier II compliance, heavily derated layouts and performance with main focus on part and low-load fuel optimisation. Very close to 100% of these engines are of the electronically controlled ME-C and ME-B types.

This paper describes cylinder condition issues, including the latest piston ring development, and the development within cylinder lubrication, including an introduction of the automated cylinder oil mixing (ACOM) system. The ACOM system needs cylinder oils with a BN higher than 100 to achieve optimum work performance. Furthermore, the developments of crosshead and main bearings are described.

The acceleration issues for ships with heavily derated engines fulfilling the energy efficiency design index (EEDI) rules have been solved by introducing larger propeller light running margins as well as implementation of dynamically optimised running modes (via the so-called Dynamic Limiter Function function). An example of such a running mode is given for a large VLOC.

In relation to electronically controlled engines, the optimisation of the ME-B engine's timing units is shown. Quality issues for the multi-purpose controllers (MPCs) are also dealt with and, furthermore, system oil cleanliness and its relation to control valve wear is outlined.

The service experience of Tier III technology, including both EGR and SCR solutions, is described and, last but not least, the first service experience with ME-GI dual fuel engines is presented.

Piston Ring Development

The increased cylinder pressures and longer process time on the latest generation of super-long-stroke S and G-type engines has called for further development of pistons and piston rings. Fig. 1 shows an example of this development in a comparison of the piston and piston ring pack for an S70ME-C8.2 and a G70ME-C9.2. On the G70 engine, the distance from the piston top to the uppermost piston ring, the piston topland, has been increased in order to protect the cylinder liner against sulphuric gases at high pressures.

Furthermore, the G70 engine is equipped with a three-ring gastight ring pack limiting the amount of hot combustion gasses penetrating the piston rings. This will limit the heat impact on the piston ring pack.



Fig. 1: Comparison of piston and ring pack for an S70ME-C8.2 and a G70ME-C9.2 with increased piston topland

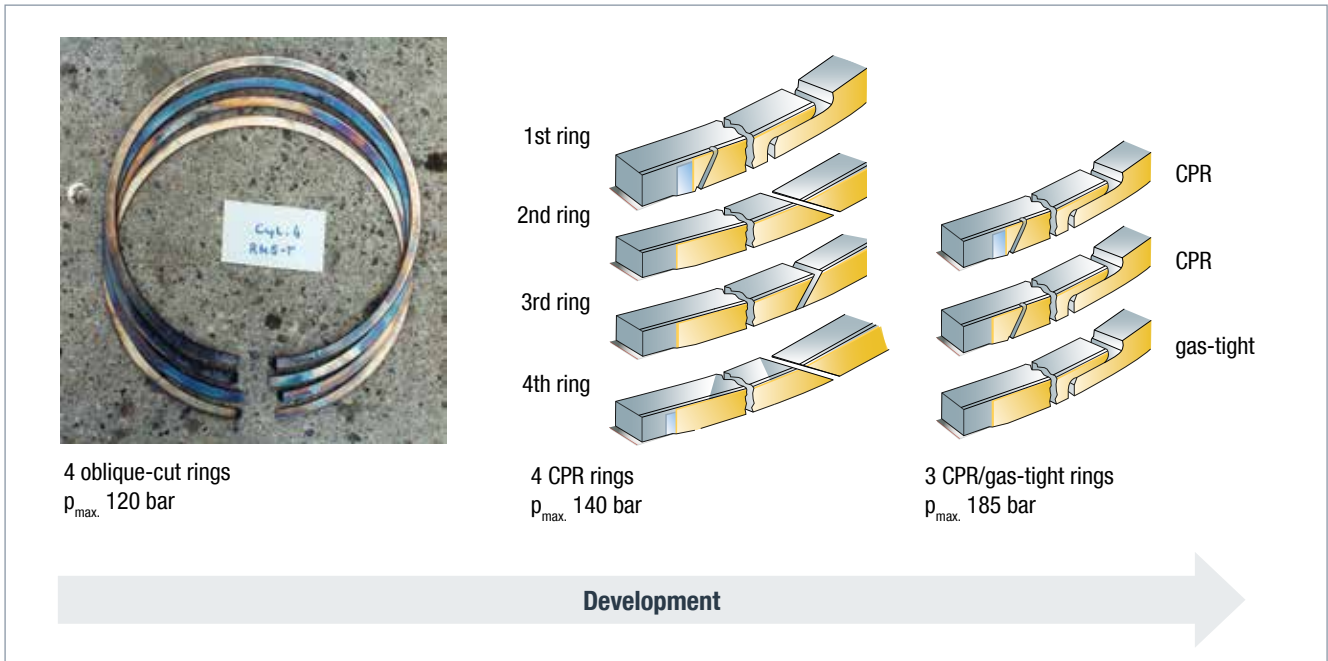

Fig. 2: Piston ring development

Fig. 2 shows a brief summary of the development of our piston rings on MAN B&W two-stroke engines over approximately three decades. The MC engine era started with adaptation of the rather simple four-ring “oblique-cut ring pack”. This simple ring pack was exhausted when the maximum pressures reached approximately 140 bar. We therefore developed the highly successful four-ring pack with a CPR top piston ring. However, this ring pack needed further development when the 9.2 Tier II engines with maximum pressures above 180 bar became the standard.

To cope with this development, we designed the gas-tight three-ring pack. Fig. 3 shows the very good service results obtained with the three-ring pack on a 6G70ME-C9.2. Clean piston ring lands and low piston ring wear can be seen.

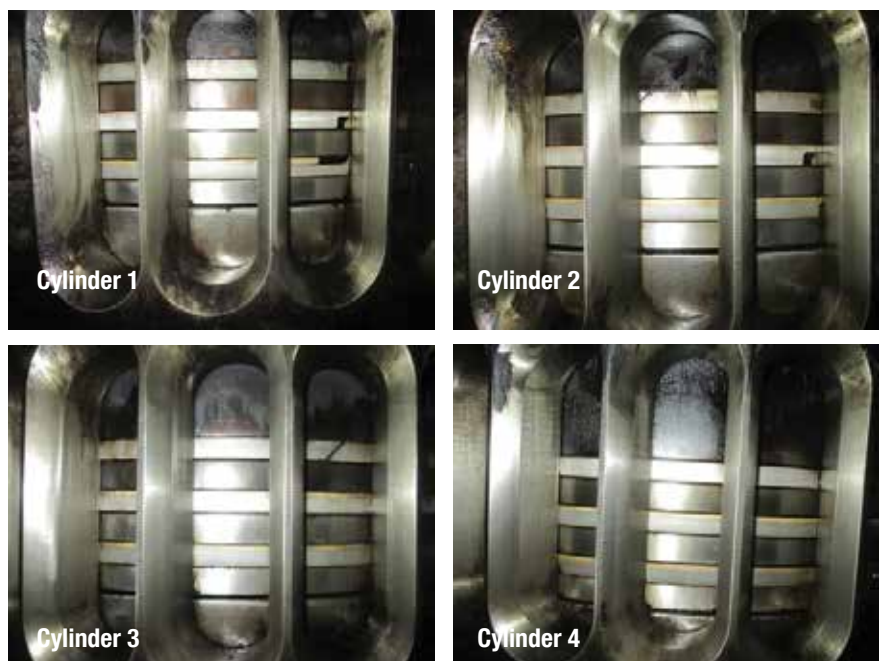

Fig. 3: Service experience with gas-tight 3-ring pack after 4,446 hours

Cold Corrosion Control

In recent years, cold corrosion has been high on the agenda at MAN Diesel & Turbo, working with fuel optimised two-stroke engines. A number of factors have been identified, which influence the degree of cold corrosion on two-stroke MAN B&W engines:

- amount of derating
- low and part load optimisation
- two-stroke Miller timing
- maximum pressure level
- waste heat recovery (WHR) application
- scavenge air temperature.

If the combustion chamber design is unchanged, derating an engine will reduce the cylinder liner temperature compared to the fully-rated engine. Lately, this has been counteracted by the introduction of the rating dependent liner (RDL) design. This will be explained in detail later in this section.

Low and part load optimisation increases the cylinder pressure levels at lower loads, which also contributes to increased cold corrosion.

Other important factors are two-stroke Miller timing, increase of maximum pressures in general and application of waste heat recovery (WHR) systems, especially when WHR is not operated on engines designed with this system.

The temperature of the scavenge air is a very important factor for the extent of cold corrosion. In order to limit the amount of water vapour entering the combustion chamber, the scavenge air temperature must always be kept as low as possible. This is also optimal with respect to the fuel oil consumption. We therefore emphasise that the freshwater temperature setpoint must always be 10°C. This ensures the lowest possible scavenge air temperature at all times, although it depends on the actual sea water temperature.

Fig. 4 shows a comparison between two engines, both of the 8S80ME-C9.2 type, operating with a scavenge air temperature of 46°C and 57°C, respectively. The tests were carried out on a twin engine installation, and the tests were done simultaneously, leaving out any difference in ambient condition, load, water under the keel, cylinder lubrication, etc.

Fig. 4 shows, during two repeated tests (T42 and T43), that the iron content in the scavenge air space drain oil is approx. twice the amount for the engine with the higher scavenge air temperature (high humidity in the air).

A number of countermeasures have been developed to prevent cold corrosion:

- jacket cooling water bypass, basic (JBB)
- load dependent cylinder liner cooling (LDCL)
- rating dependent liner designs (RDL)

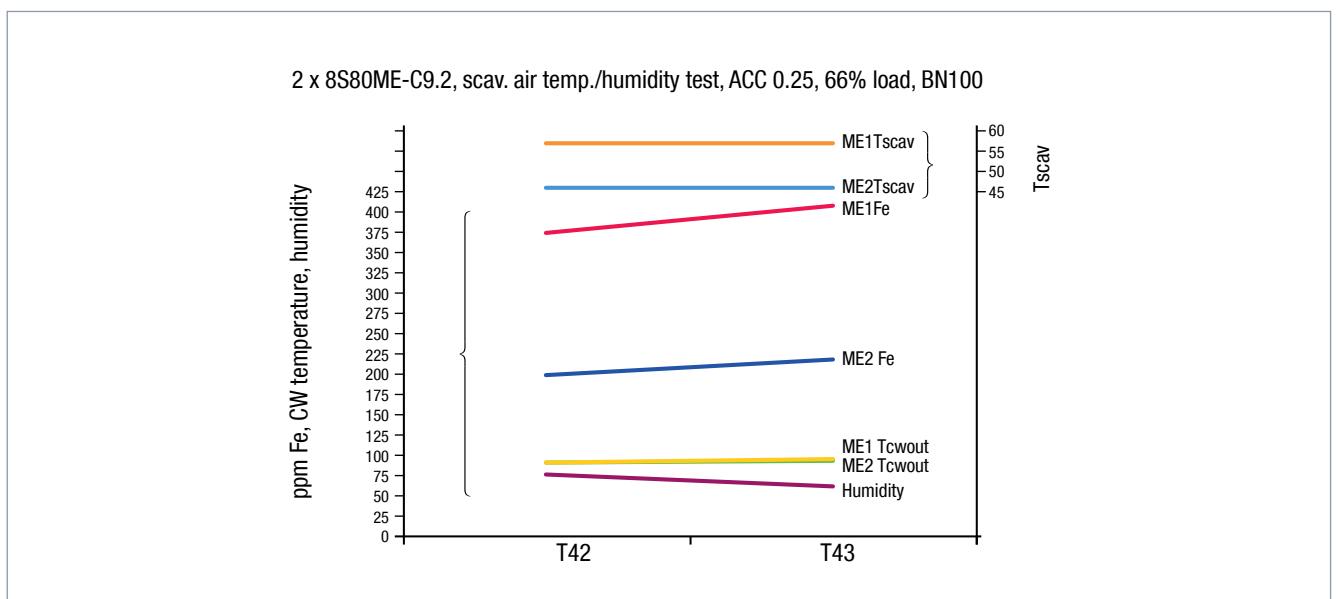

Fig. 4: Corrosive wear - water in scavenge air

The cylinder oil feed rates have been reduced by introducing these counter-measures.

A very important step in the control of cold corrosion, while also maintaining reasonable cylinder oil feed rates, has been the introduction of the BN100 cylinder oil. The BN100 cylinder oil, which is now the standard on newer MAN B&W two-stroke engines, gives better than “BN-proportional” protection against cold corrosion compared to a BN70 cylinder oil.

However, the development in this area does not stop here – we are now testing a BN140 cylinder oil in combination with a new cylinder oil lubrication system, where a variable BN level is applied for fuels (liquid or gaseous) with large variations in sulphur content. We have denoted the system automated cylinder oil mixing (ACOM).

Fig. 5 shows the outline of the jacket cooling water bypass basic (JBB) system. The amount of bypassed cooling water is controlled by a fixed orifice in the jacket cooling water outlet from the cylinder liner cooling space.

At a bypass amount of 75-85% of the jacket cooling water flow a cylinder liner temperature increase of 15-25°C is obtained at all loads.

Fig. 6 shows the load-dependent cylinder liner cooling system – the LDCL system. With the LDCL system, the temperature of the jacket cooling water for the cylinder liner can be varied with the load in such a way that a very high temperature of the cooling water is maintained in the low and part load

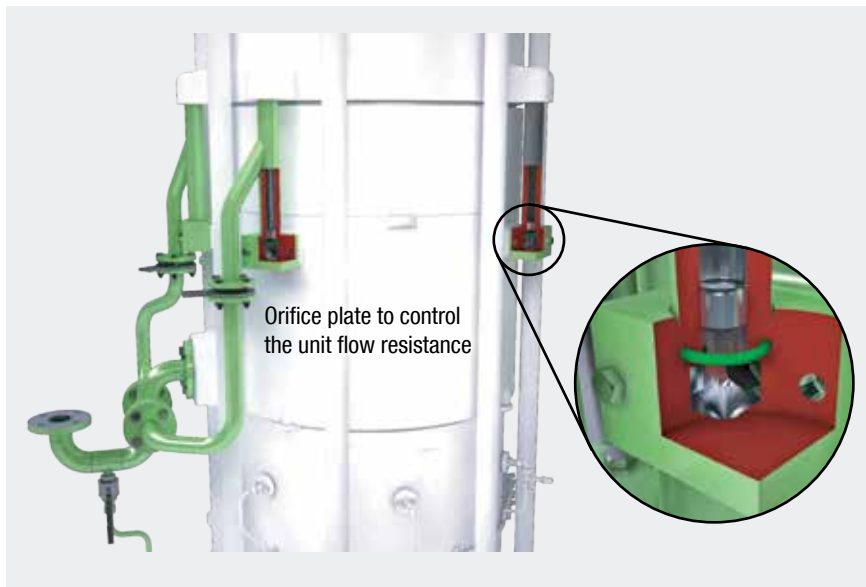

Fig. 5: Corrosive wear - increased liner temperature by JBB

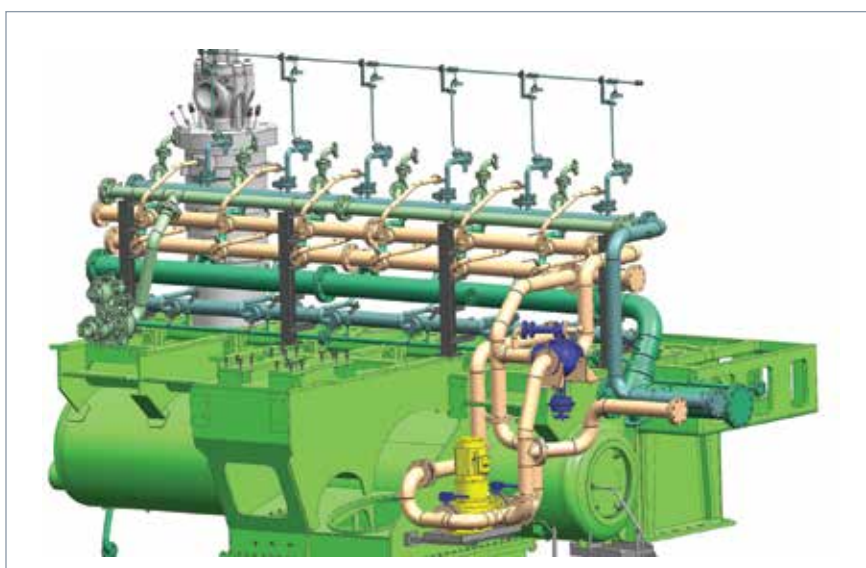

Fig. 6: Load-dependent cylinder cooling system (LDCL)

range. At high loads (typically above 80% load), the LDCL system is operated “passively”, and the jacket cooling water temperature for the cylinder liner is not raised. In this way, a 30-40°C increase of the liner temperature can be obtained at low and part load without overheating the cylinder liner in the full load range.

A further improvement in the combustion chamber design is the rating dependent liner (RDL) design mentioned previously. Traditionally, the temperature profile of the uppermost part of the cylinder liner has been determined by the maximum allowable temperature at the very top of the cylinder liner for a fully rated (L1) engine.

When this type of cylinder liner is applied in a heavily derated engine (L4-L2 line), the cylinder liner wall temperature is typically 40°C lower in the uppermost 300 mm of the liner running surface. To counteract this problem, we have decided to design three cylinder liners for each engine type.

Fig. 7 shows the division of the layout diagram into three subareas. Besides, the figure shows that the RDL design for the lower rating range has the same temperature profile as the cylinder liner for the fully rated engine. The example shown is for a G70ME-C9.2 engine, but all our Mark 9 and 10 engines from 50-cm bore and up will have the RDL concept.

In order to get an overview of the different factors influencing the cold corrosion levels of various engines, the term “lubrication index” has been developed. The lubrication index concept summarises all factors influencing the cold corrosion level in one integer. The factors which provoke or create cold corrosion are given negative integer values, for example:

- two-stroke Miller timing: 0 to -3
- LT cooling water temperature set-point: 0 to -2
- layout point (level of derating): 0 to -4
- optimisation method (EGB, VTA, T/C cut-out): -1 to -3.

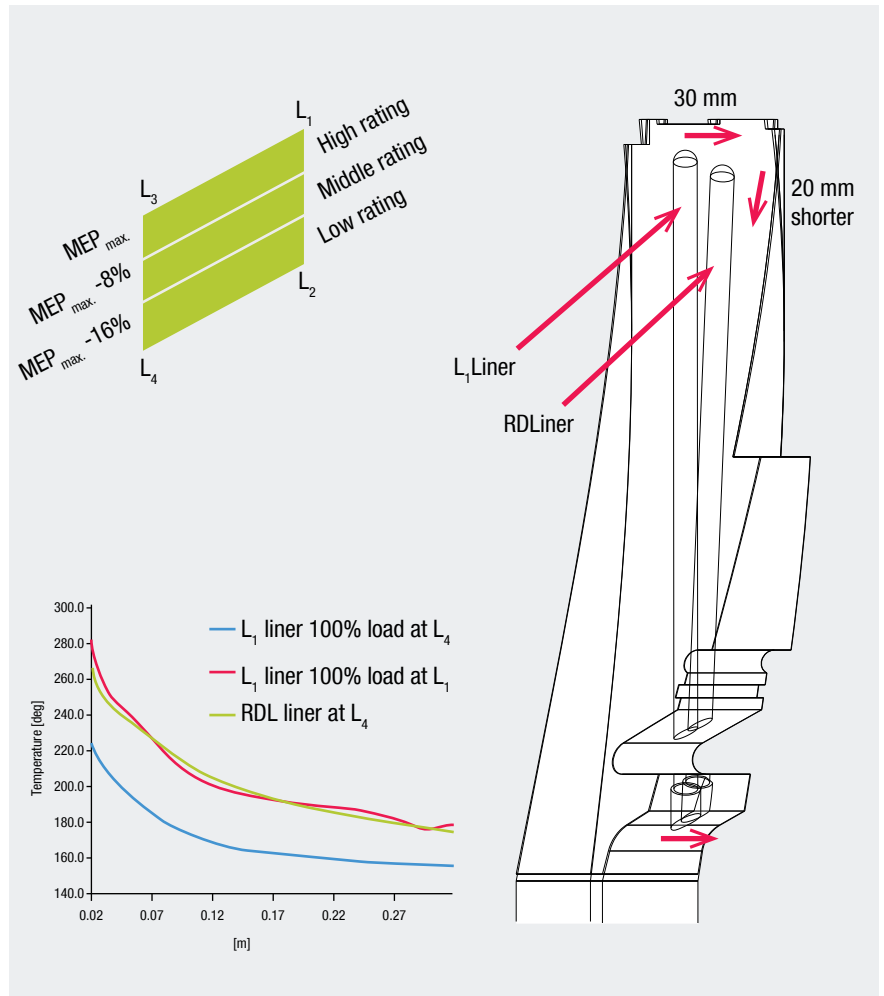

Fig. 7: Rating dependent liner (RDL)

Factors influencing the degree of cold corrosion in a positive or reducing way are given positive integer values, for example:

- piston topland high: -1 to +1
- RDL concept: +1 to +4 (depending on rating)
- LDCL system: 0 to +3 (depending on load)
- JBB system: +1 to +2 (depending on bypass rate).

Table 1 compares two series of 50k MR tankers, both equipped with 6G50ME-B9.3 engines. The first series is not equipped with the RDL concept or the LDCL system, whereas the other series has both countermeasures. As can be seen, the lubrication index varies a lot for the two tanker series, -4 and -10 respectively.

Table 2 shows the very big difference in cylinder oil consumption for the two series of vessels, which in principle are equipped with the same engine type, the 6G50ME-B9.3. The table estimates how the cylinder oil consumption will be influenced by keeping the lowest possible scavenge air temperature. If the counter-measures discussed are applied as well as keeping the lowest possible scavenge air temperature, very attractive specific cylinder oil consumption is foreseen.

However, we emphasise that the lubrication index system is only based on estimations. The determination of the

50k tanker 1st series		
Miller timing	yes, high	-3
Layout point	MEP 16.8 bar	-3
Part load optimisation	EGB	-2
LT cooling water temp. set point	36°C	-2
Topland height	high	0
Liner cooling	normal	0
Countermeasures jacket cooling water	No countermeasures	0
Lubrication index		-10
50k tanker 2nd series		
Miller timing	yes, high	-3
Layout point	MEP 16.8 bar	-3
Part load optimisation	EGB	-2
LT cooling water temp. set point	32°C	-2
Topland height	high	0
Liner cooling	RDL	3
Countermeasures jacket cooling water	LDCL	3
Lubrication index		-4

Table 1: Lubrication index system

actual minimum specific cylinder oil consumption should be based on cylinder oil sweep testing as outlined in our service letter SL2014-587/JAP.

Engine		Lubrication index R	ACC _{BN70} g/kWhxS%	ACC _{BN100} g/kWhxS%	Lubrication index R	ACC _{BN100} g/kWhxS%
		36 °C set point LT cooling water			10°C set point LT cooling water	
50k tanker 1 st series	6G50ME-B9.3	-10	0.64	0.45	-8	0.39
50k tanker 2 nd series	6G50ME-B9.3	-4	0.37	0.26	-2	0.20

$ACC_{BN100} = (0.20 + 0.4/9*(-R))*70/100$
 $ACC_{BN70} = 0.20 + 0.4/9*(-R)$
 ACC (Adaptive Cylinder oil Control)

Table 2: Lubrication index and ACC factors

Cylinder Lubrication – The Near Future

We approach times where the sulphur equivalent of the fuel (liquid or gaseous) will vary to a great extent. This goes for conventional diesel engines operating in and out of SECA areas and for ME-GI/LGI engines also operating in and out of SECA areas with varying amounts of sulphur content in the pilot fuel oil.

MAN Diesel & Turbo develops a system, which will be integrated in the ME electronic control system (ME-ECS), for mixing of two approved cylinder oils with different BN numbers, i.e. a low-BN cylinder oil is mixed with a high-BN cylinder oil.

We denote the system automated cylinder oil mixing (ACOM), see Fig. 8.

The ACOM unit consists of three small tanks: one for low-BN cylinder oil, one for high-BN cylinder oil and one for the mixed optimal BN cylinder oil, see Fig. 9. When an ACOM unit is installed on a vessel, the normal day tank for cylinder oil can be avoided. The ACOM unit takes cylinder oil directly from the cylinder oil storage tanks. The ACOM unit seen in Fig. 9 is a prototype version without ME-ECS integrated control.

When applying the ACOM unit, it is essential that the optimal cylinder oil feed rate factor (ACC factor) is known. This knowledge is gained by making a cylinder oil sweep test.

- Mix a high BN and a BN25 cylinder oil “step-less”
- Blending range from BN25 to **BN100 or higher**
- Ensure optimal BN at **minimum feed rate** at anytime
- Significantly reduced cylinder oil dosages
- Minimum feed rate result in increased lubricating efficiency
- Always correct viscosity and optimal detergency
- Quick change between BN levels when changing fuel (in/out of SECA)

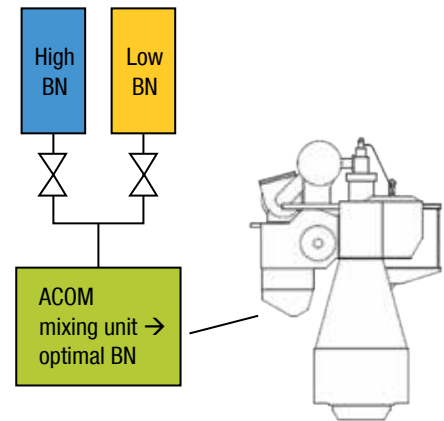

Fig. 8: Automated cylinder oil mixing (ACOM)

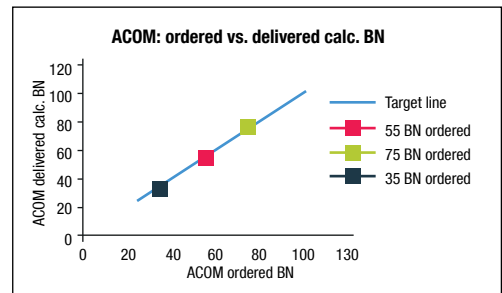

Fig. 9: Automated cylinder oil mixing (ACOM) unit

When the ACC factor is known, it is keyed in on the main operating panel (MOP) on the cylinder oil control screen. The sulphur content of the fuel for ME engines is also keyed in on the MOP or, if it is dual fuel ME-GI/LGI engines, the sulphur content of the two fuels used. The ACOM software will then calculate the lowest possible optimum cylinder oil feed rate.

Fig. 10 shows the variations in cylinder oil BN for different equivalent fuel sulphur contents from 0% to 3.5%. Curves for various ACC factors are shown, and it can be seen that it will often be possible to apply the minimum feed rate of 0.6 g/kWh.

In the example in Fig. 10, BN25 and BN140 cylinder oils are mixed. MAN

Diesel & Turbo believes that cylinder oils with a BN higher than 100 is necessary to be able to take full advantage of the ACOM system. Tests are presently being conducted with various brands of BN140 cylinder oil.

The reason for asking for a further increase of the cylinder oil BN is that we will have an increased “lubrication efficiency” with the lowest possible absolute cylinder oil feed rate. We will lose the lowest percentage of unused cylinder oil if we feed the lowest possible amount of oil into the combustion chamber. It is equivalent to painting a wall with a paint brush – if too much paint is applied on the brush, a high percentage is lost on the floor.

Table 3 outlines the theoretic cost increase when the BN number of the cylinder oil is raised. As shown, a 100% increase of BN (from BN70 to BN140) can be obtained for a cost increase of 19-32% depending on the ratio of cost between the additive package and the base oil.

Additive (BN300) cost = 2 x base oil cost	
BN70:	100%
BN100:	108%
BN140:	119%
Additive (BN300) cost = 3 x base oil cost	
BN70:	100%
BN100:	114%
BN140:	132%

Table 3: Cost of high-BN cylinder oils

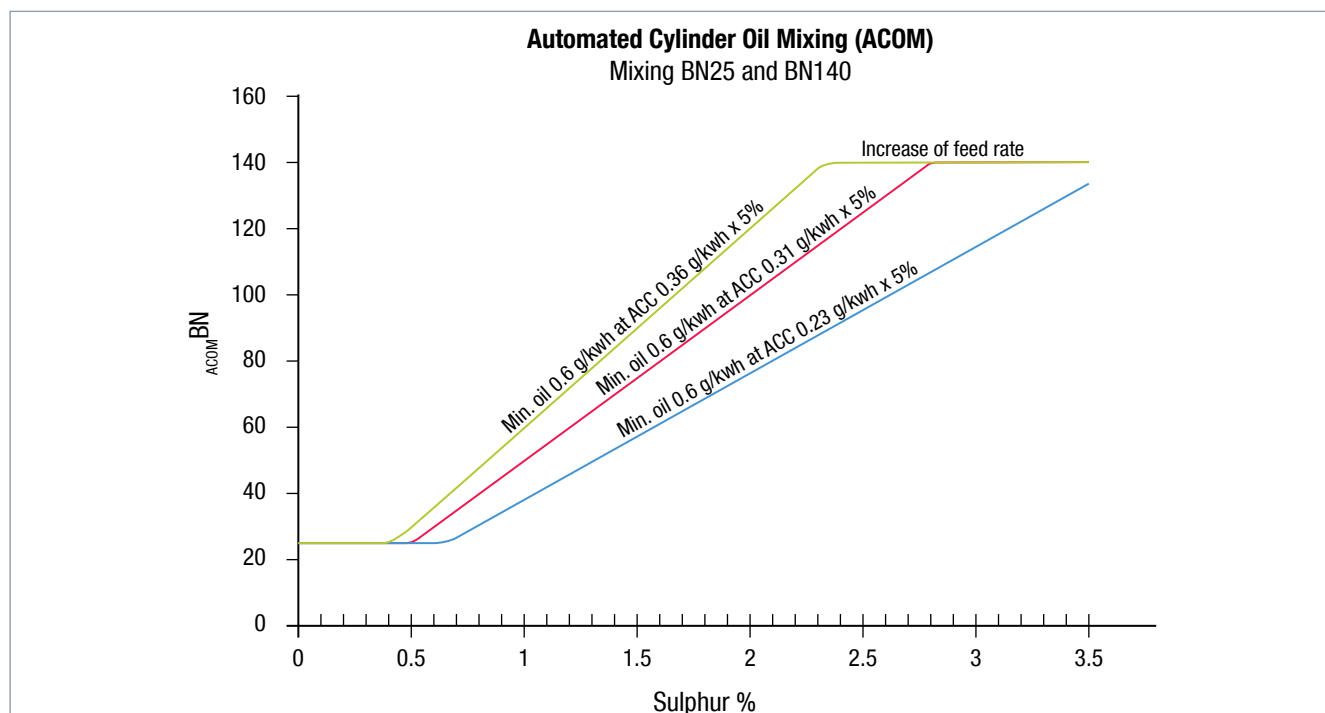

Fig. 10: Automated cylinder oil mixing (ACOM)

Crosshead Bearing Design for S and G-Type Engines (Mark 9 & 10)

A new crosshead bearing assembly design has been introduced on the latest generation of MAN B&W two-stroke engines, to cope with the increased maximum pressure. The new design is termed the wide-pad design, and it has been gradually introduced on all new engine designs from 2007 and onwards.

Since 2012, the wide-pad design has also been introduced on the large 80-

cm and 90-cm bore engine types. The wide-pad designation refers to the uninterrupted centre pad in the loaded lower bearing shell. The oil grooves in this centre pad have been omitted, and the distance between the axial oil grooves has also been widened.

The major difference between the traditional MAN B&W crosshead bearing design and the wide-pad design is illustrated in Fig. 11.

Compared to the traditional design, a comparative elasto-hydrodynamic bearing calculation gives the much lower oil film pressure in the wide-pad design. Furthermore, the minimum oil film thickness is larger in the new wide-pad design for the same running condition.

Crosshead bearings are exposed to the highest load on heavily derated engines operating with a high maximum pressure at relatively low revolutions. Crosshead bearings subjected to this load pattern have therefore been inspected.

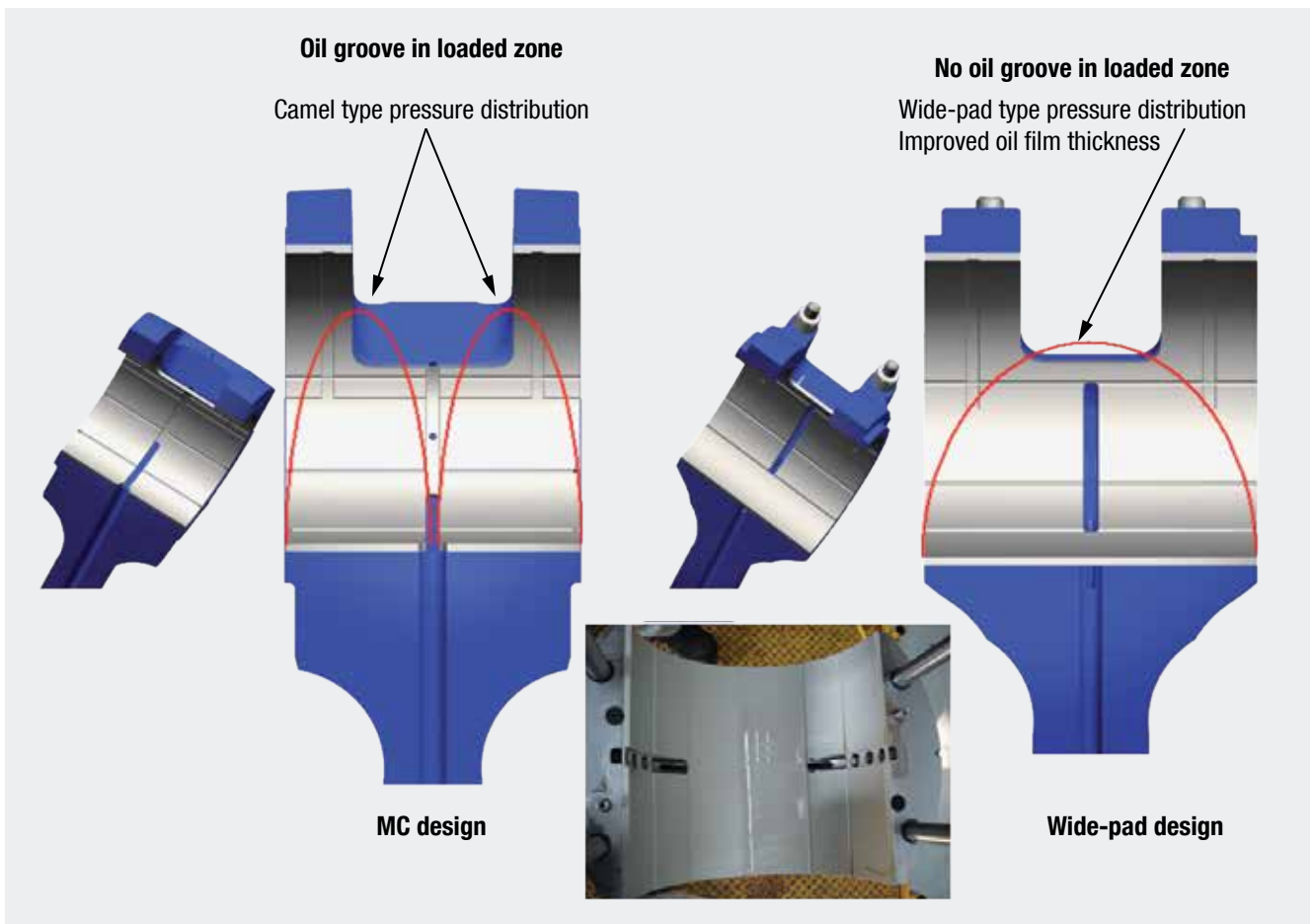

Fig. 11: MAN B&W crosshead bearing designs

A 7G80ME-C9.2 was first inspected after sea trial and then again after 6,600 running hours.

Fig. 12 shows the condition after sea trial, which is very good with well-distributed bearing load over the entire bearing shell.

Figs. 13 and 14 show the condition of the bearings No. 4 and No. 6, respectively, after 6,600 hours of operation. Good contact can be seen on the centre pad and far up on the lower side pads.

Only insignificant local wiping is visible on the lead overlayer. This is a natural part of the bearing adaption using redistribution of the lead overlayer. This redistribution of overlayer has occurred within the first running hours in service. No indications of micro-cracks or other abnormalities can be seen.



Fig. 12: 7G80ME-C9.2 – crosshead bearing after sea trial

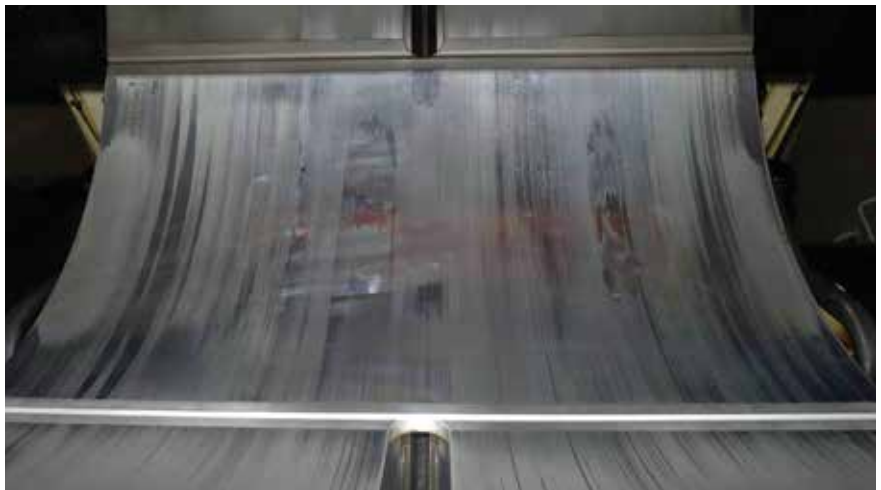

Fig. 13: 7G80ME-C9.2 – crosshead bearing #4 after 6,619 hours

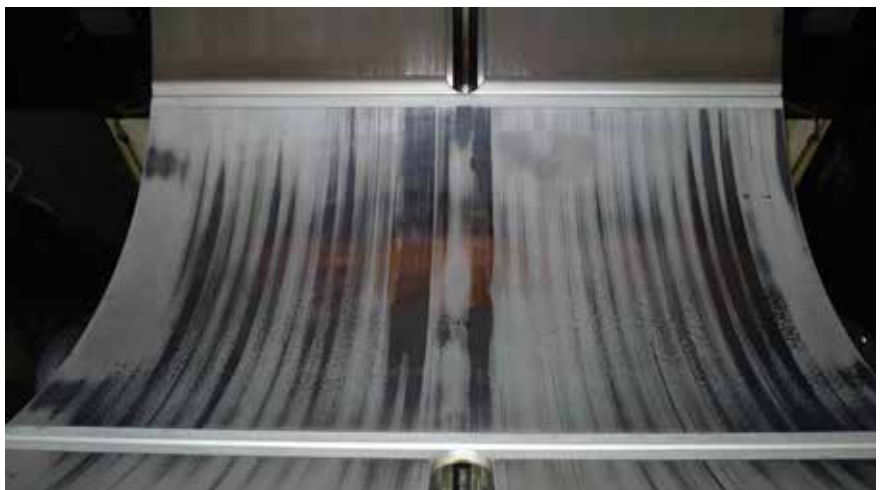

Fig. 17.14: 7G80ME-C9.2 – crosshead bearing #6 after 6,619 hours

Main Bearings

We have introduced so-called blended-edge (BE) bearings on our superlong stroke S and G-type engines. The background for this introduction is large main journal inclinations in some bearing positions during the cycle, see Fig. 15.

Elasto-hydrodynamic bearing calculations show the benefit of increasing the low oil film thickness on the edge created when blended-edge bearings are applied. The static bearing imprint, as shown in Fig. 16, is normal when BE bearing shells are applied – the static imprint does not reach the edges of the bearing.

As an example, the application of blended-edge bearings is shown in Fig. 17 on a 10S90ME-C9.2 engine. The bearing positions 1, 2, 4, 8, 9, 10, 11 and 12 are specified as BE bearings, whereas positions 3, 5, 6, 7, 13 are specified as straight-edge bearings.

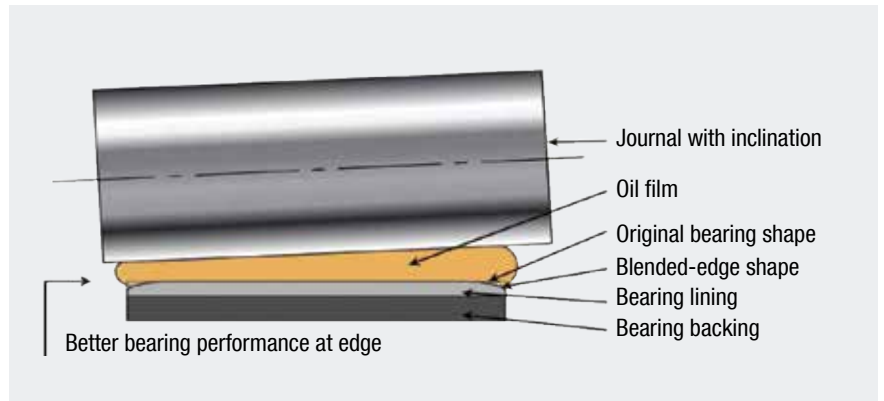

Fig. 15: Blended-edge main bearing principle

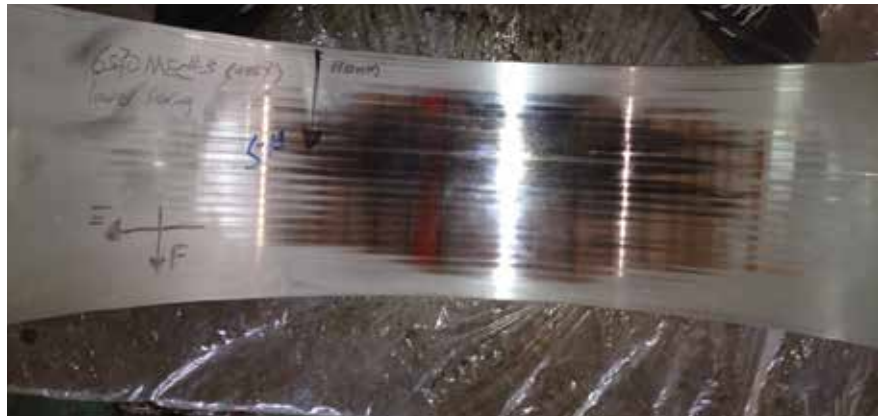

Fig. 16: Static bearing load imprint on a BE-type bearing

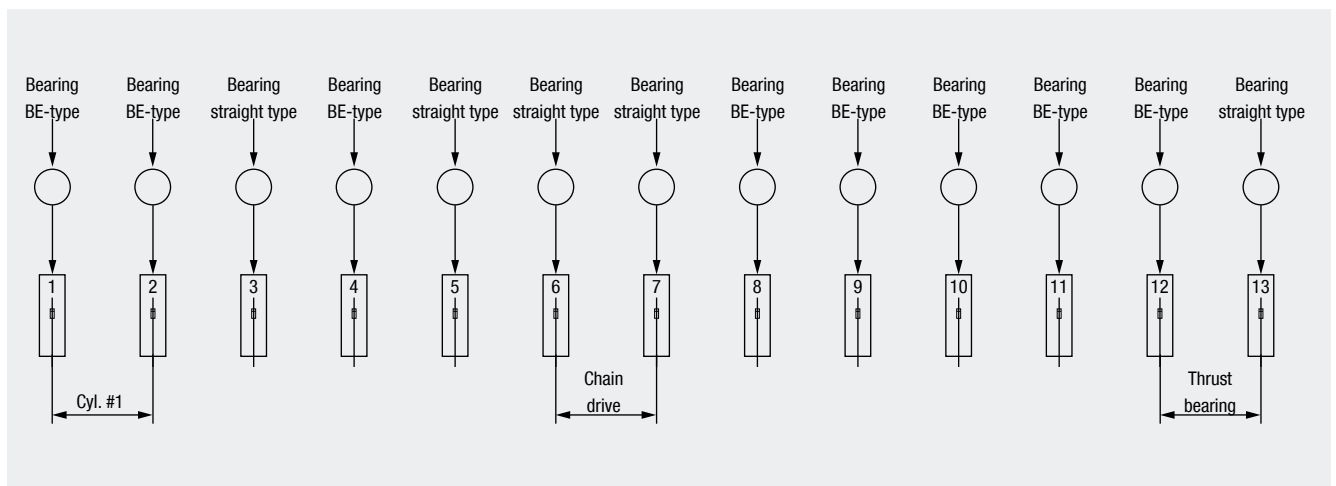

Fig. 17: 10S90ME-C9.2 – blended-edge (BE) configuration

Fig. 18 shows fatigue damage on the edge in bearing position No. 5, where a straight-edge main bearing was originally installed. The static bearing imprint indicates that a concave geometry exists in this bearing assembly, and a “straight-edge” check reveals that the main journal is concave. In this case, a BE lower bearing shell was installed, and the issue was eliminated. This example shows that the BE bearing design is also able to remedy geometric imperfections in the bearing assemblies even when this has not been the main driver for the BE main bearing development.

Engine and Ship Acceleration Issues

Lately, we have received reports on slow engine/ship acceleration, long time to pass barred speed ranges and low power availability at heavy head sea. These reports are a consequence of the introduction of the energy efficiency design index (EEDI) for all ship types typically decreasing the power installed and the designed vessel top speed. The reports are concentrated on certain vessel types, mainly bulk carriers and oil tankers.

MAN Diesel & Turbo has counteracted this development in two ways:

1. By specifying an increased propeller light running margin (LRM).
2. By introducing a special transient running mode called Dynamic Limiter Function (DLF).

For the propeller light running margin, we have changed our recommendation from 3-7% to 4-10% depending on the vessel design. By doing so, the propeller curves are pushed to the right in the

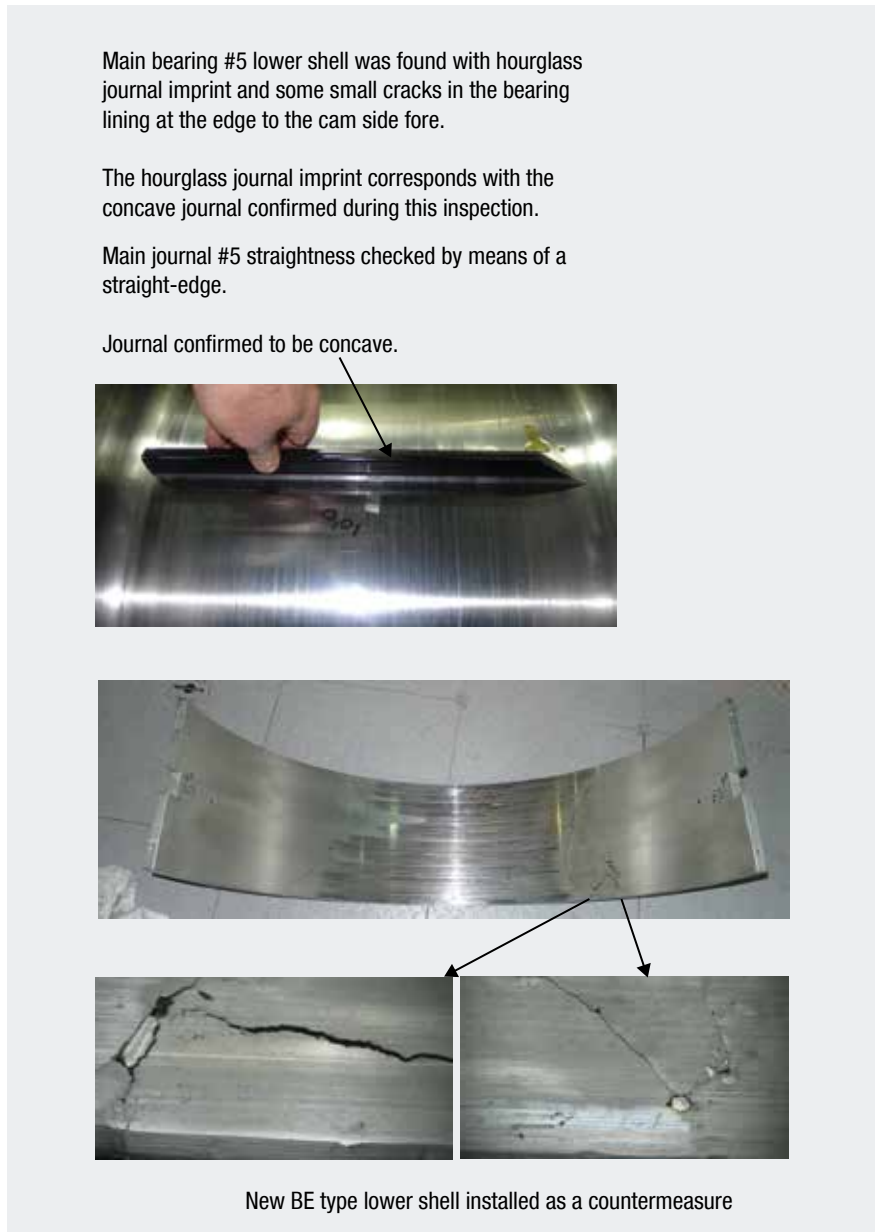

Fig. 18: 10S90ME.C9.2 – main bearing #5 failure after 5,271 running hours

load diagram, thereby increasing the margin in heavy load conditions, see Fig. 19.

In order to protect the engine against excessive heat load, and as the DLF is only operative for up to 30 minutes, an adequate propeller light running margin is needed to ensure a good engine performance when the vessel is operating

in heavy weather with strong head seas over a long period of time.

However, we have also increased the torque capability of the main engine by utilising the full control of the fuel injection and exhaust valve timing on the ME-C engine types, see Fig. 19. We have developed a version of our ME engine control software (ME-ECS) that

utilises the actual pressures in the combustion chamber in transient condition during the acceleration stage. This has led to the revised torque limiter and a replacement of the traditional scavenge air limiter with a new “lambda limiter”.

The DLF running mode is only meant to be used for up to 30 minutes at a time. The DLF running mode will decrease the time for passage of the barred speed range as well as assist in obtaining better acceleration properties for the vessel.

We have tested the new ME software on various vessels. One example of such testing was carried out on a large bulk carrier with a fully derated 6G80ME-C9.2 engine installed. The vessel properties are shown in Fig. 20.

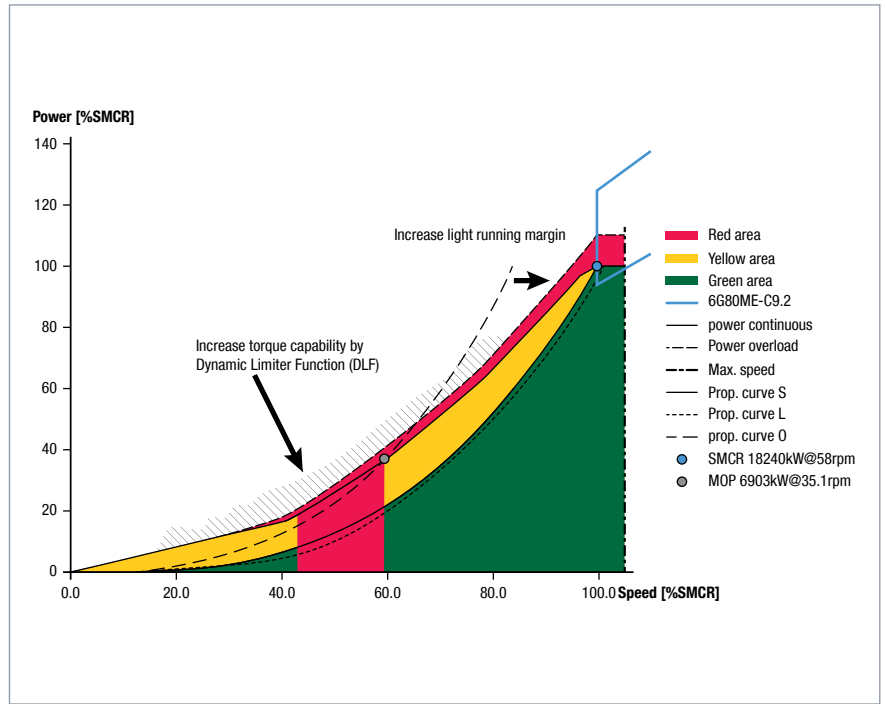

Fig. 19: Two ways to increase acceleration and decrease time passing BSR

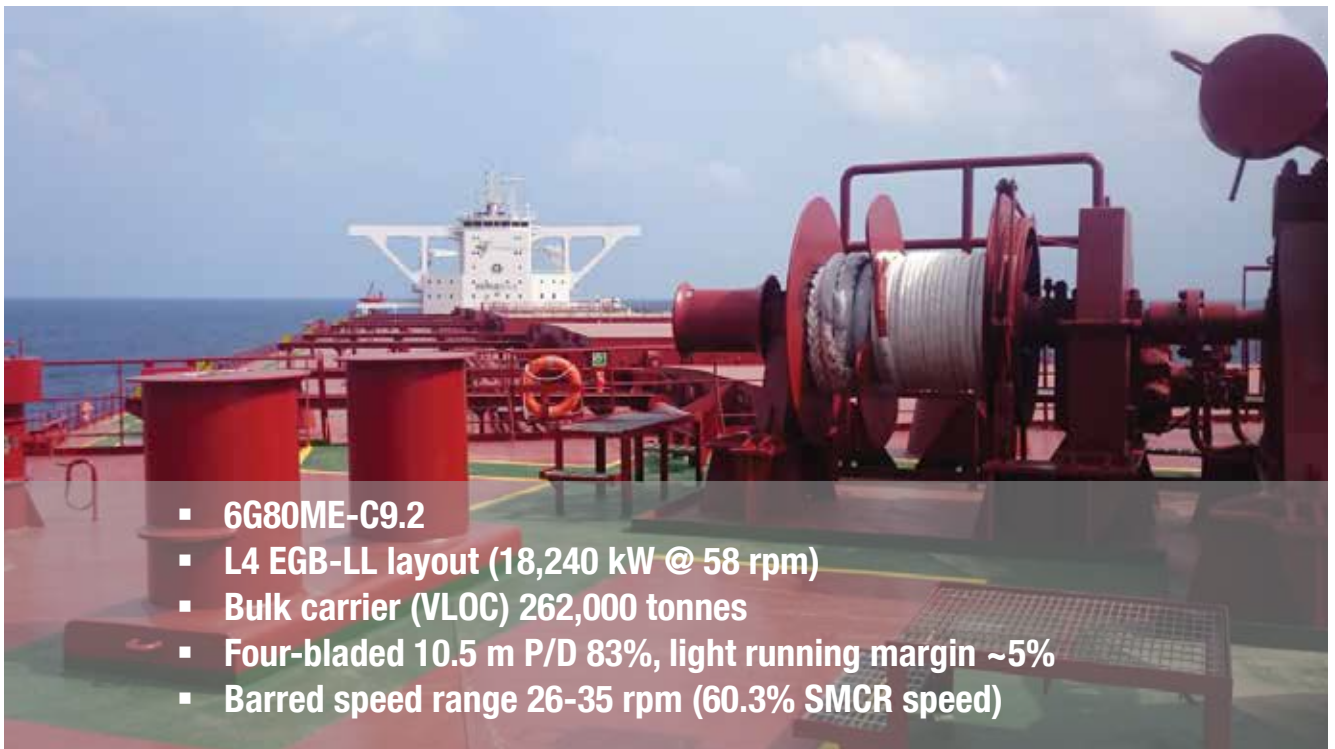

Fig. 20: Test vessel for dynamic limiter function tests

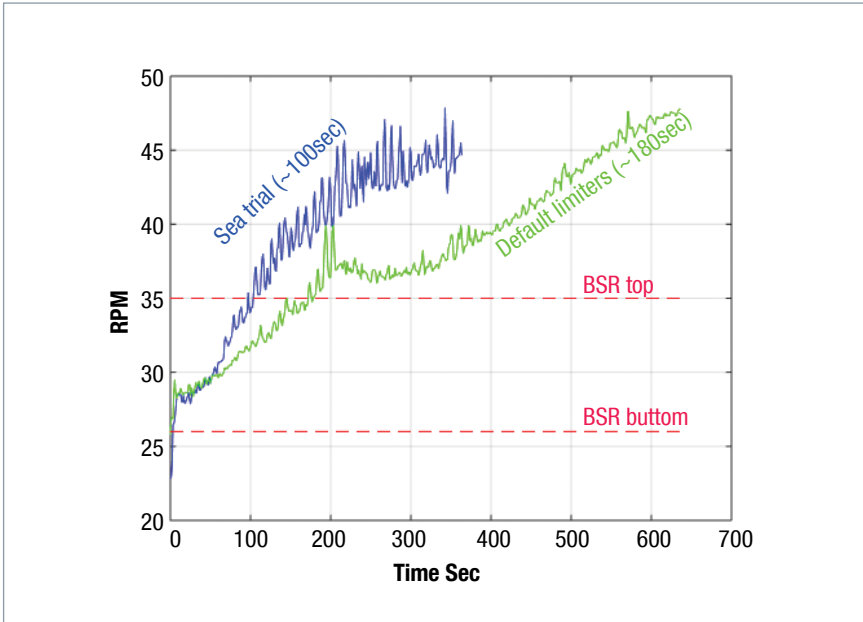

Fig. 21: Dynamic limiter function - reference tests

The vessel had been on sea trial and was delivered with a standard version of the ME software. Fig. 21 outlines the passage time of the barred speed range with standard default limiters (180 secs) and with increased limiters (100 secs), respectively.

DLF software with increased torque capability, see Fig. 22, was tested on the maiden voyage and passage time of the barred speed range was reduced to 20 secs, Fig. 23.

To confirm the performance of the DLF software, the vessel was visited again in Port Hedland, Australia. Here, both the acceleration performance and the intermediate shaft torsional stresses were recorded during departure in fully loaded condition with typical head current and shallow water under the keel of the vessel. Fig. 24 indicates that the total passage time of the barred speed range in this condition was approx. 39 secs. Torsional stresses in the intermediate shaft were within acceptable limits, and the owner and, not least, the pilot in Port Hedland were impressed by the acceleration performance of the vessel.

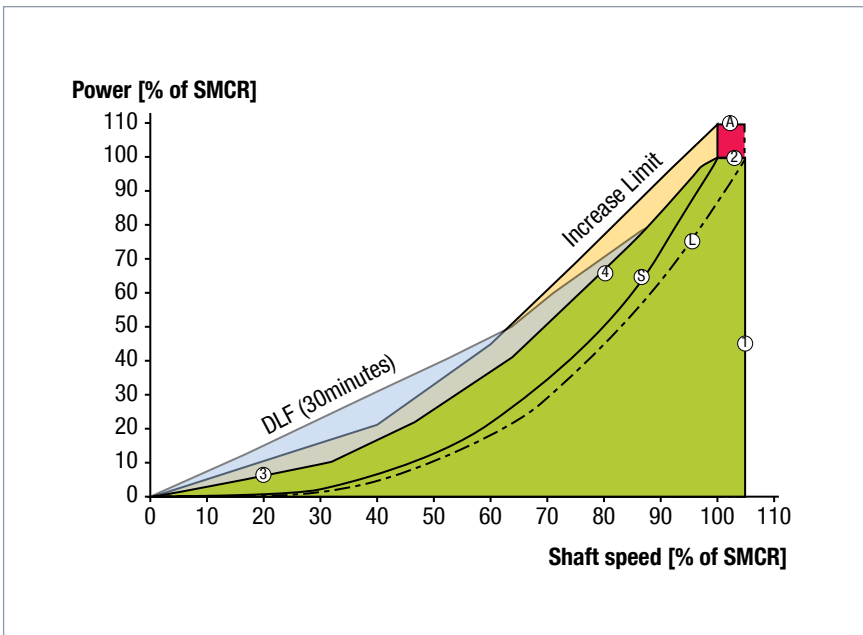

Fig. 22: Torque limiter in the diagram - DLF allows higher temporary load

We are now able to deliver standard ME software with DLF embedded, and the DLF feature can be enabled whenever needed.

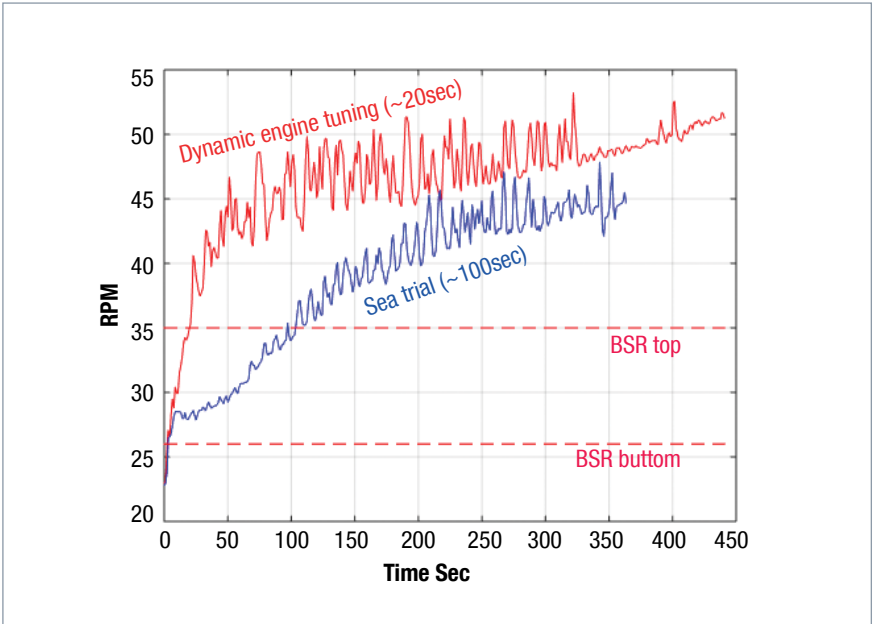

Fig. 23: Dynamic limiter function – effect of dynamic tuning

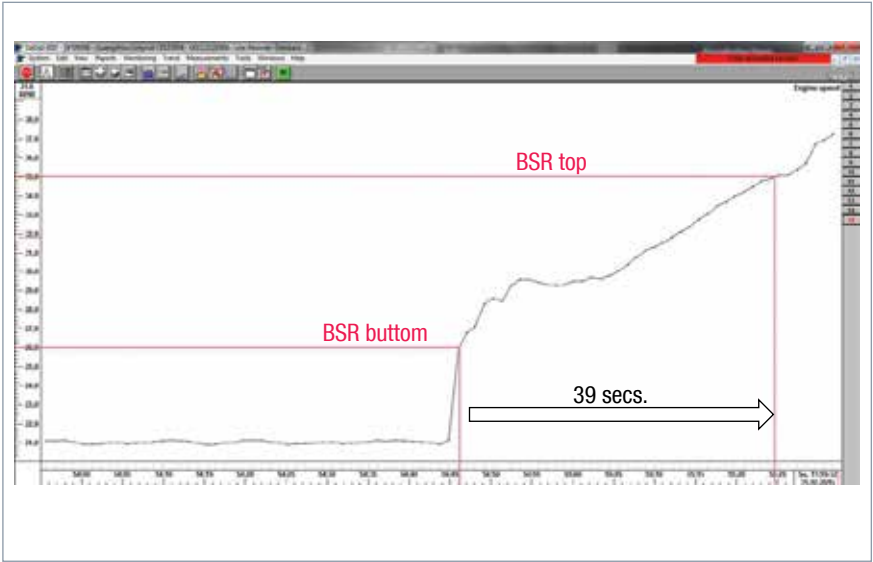

Fig. 24: Dynamic limiter function – further results in fully loaded condition out of Port Hedland, Australia

Variable Exhaust Valve Timing on ME-B Engines

The exhaust valve timing on the original ME-B engine types (designated ME-B9.2) was fixed according to the cam profile chosen.

Variable exhaust valve timing was introduced to achieve a better part-load performance by using a shorter cam profile and a hydraulic push rod extension at the full load range. This allows control of the pressures by delaying the exhaust valve closing time, see Fig. 25.

Engines designed with variable exhaust timing are designated ME-B9.3/5, and the exhaust valve actuation unit is referred to as the "ME-V timing unit".

Fig. 26 illustrates how the ME-V timing unit works when it is active from around 55% engine load and higher. However, we have experienced that air may accumulate in the ME-V timing unit, which can lead to unstable operation. This is illustrated in Fig. 27, which also illustrates that this condition is temporary until the air in the ME-V timing unit has been vented. Nevertheless, this gives rise to alarms and undesirable running conditions until a stable condition is reached.

In order to counteract this phenomenon, we have developed ME-ECS parameters for so-called dummy actuation (pressurising) of the ME-V timing plunger. Fig. 28 illustrates such a dummy actuation where the ME-V timing unit is pressurised and de-pressurised before the pressure in the hydraulic push rod is sufficiently low to allow movement of the ME-V timing piston. This is done from 0% to 55% load, and

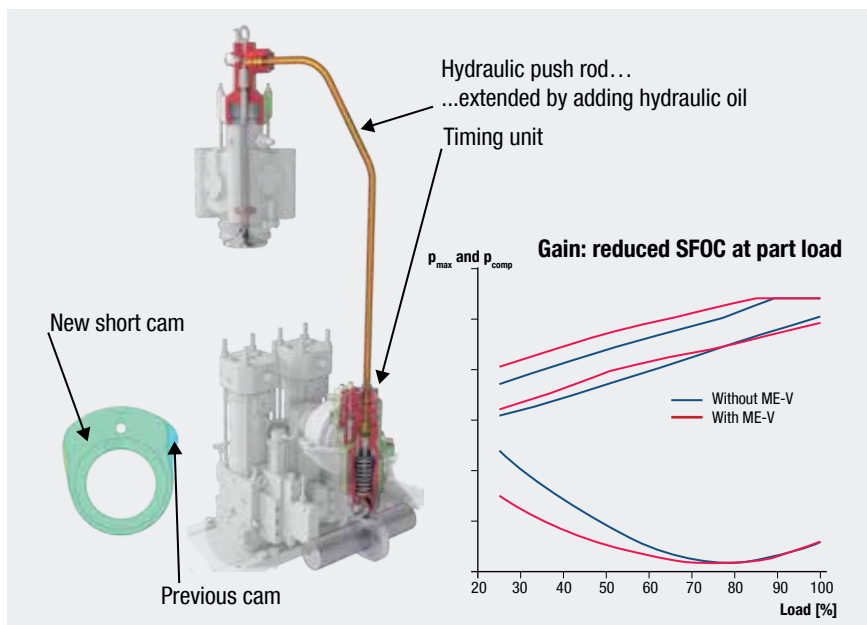

Fig. 25: Variable exhaust valve timing principle for ME-B

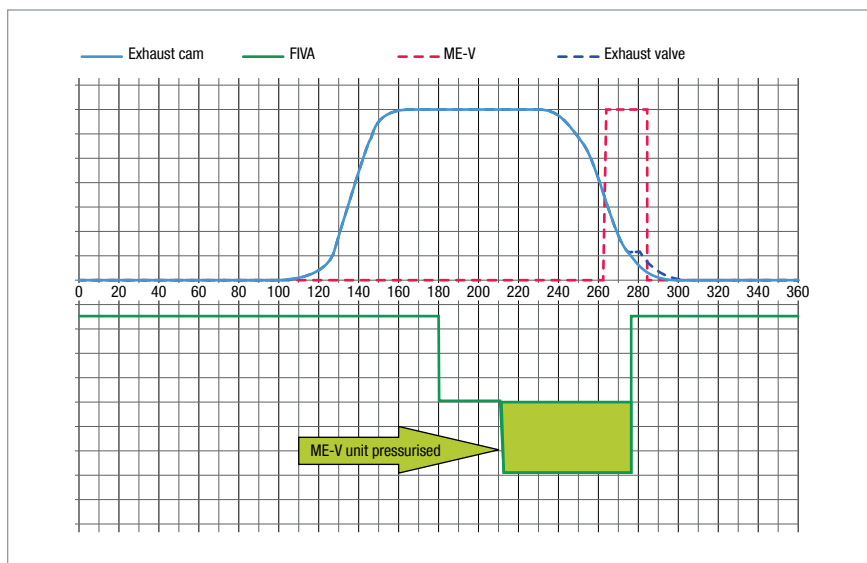

Fig. 26: "Normal" control above 55% load

it means that any air has been vented when real actuation is needed, and immediate functioning of the ME-V timing unit is ensured without any delay and risk of alarms, see Fig. 29.

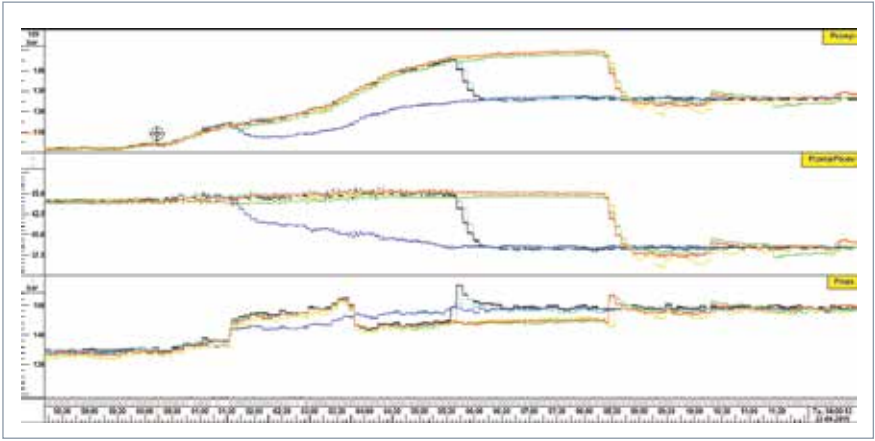

Fig. 27: Load up – ME-V failure

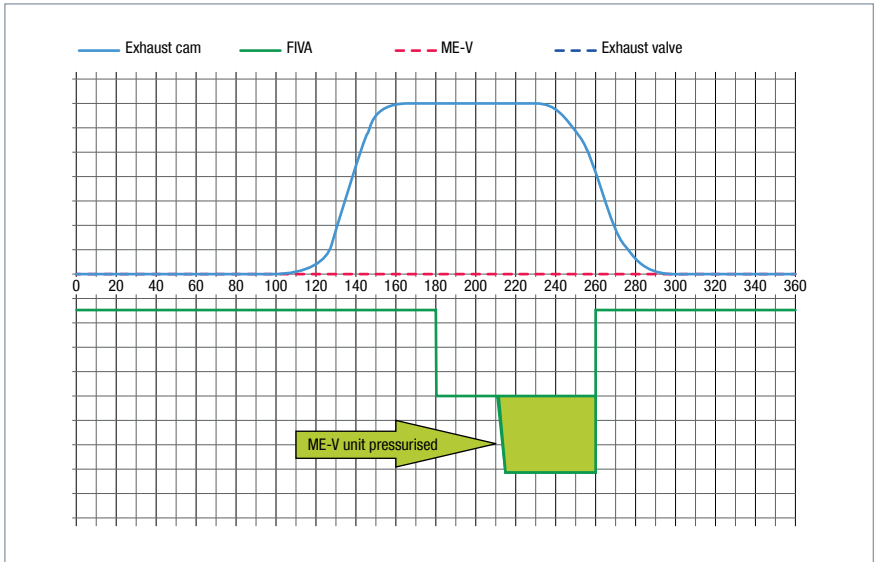

Fig. 28: "Dummy" actuation – 0% to 55% load

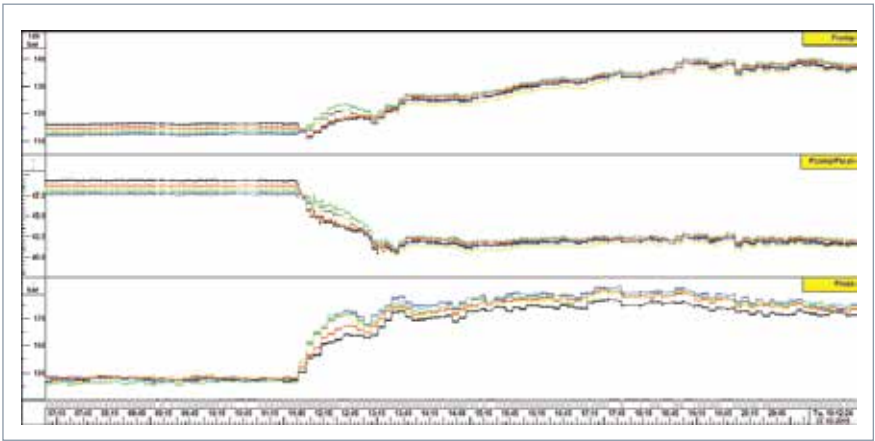

Fig. 29: Load-up with dummy actuations from 0 to 55% load - no failures

ME-B9.3 Inductive Sensors

The inductive sensor on the ME-V timing unit on ME-B9.3 engines, see Fig. 30, are applied in the following two designs:

- Pepperl & Fuchs
- Contrinex

In the second half of 2015 we recorded an increase in failure rates in the Pepperl & Fuchs version of the sensor. Approximately 3,900 units of the Pepperl & Fuchs sensors were in service by that time. Furthermore, the Pepperl & Fuchs sensors have been applied on the Alpha Lubricators since 2000 with a number in service of some 100,000 units. For this application we have not seen elevated failure rates.

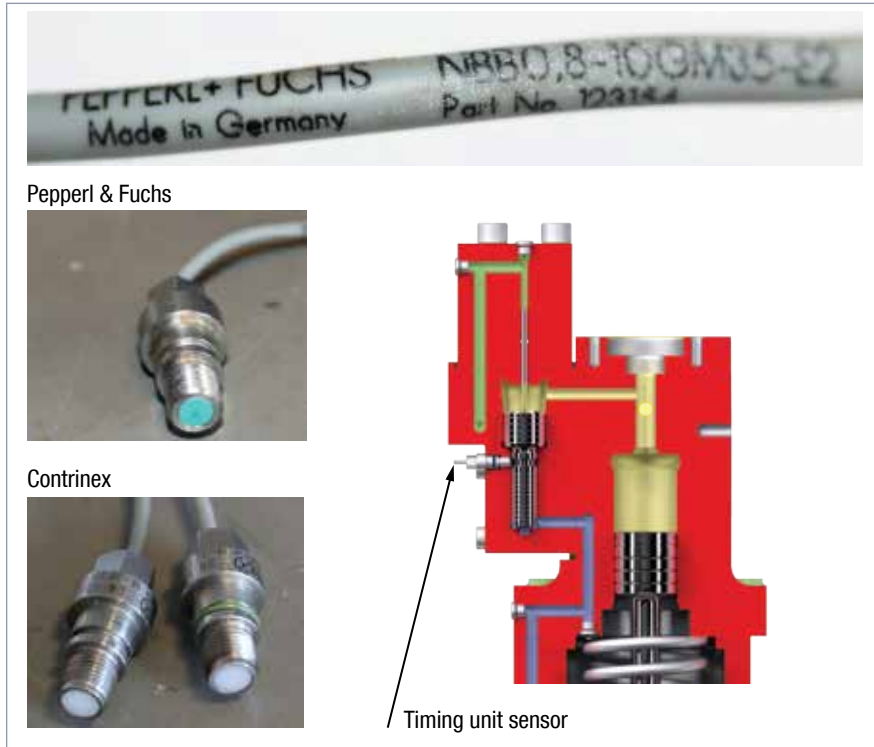

Fig. 30: The Pepperl & Fuchs and Contrinex inductive sensors

Pepperl & Fuchs were asked to produce a root cause analysis in relation to the failures of the sensors used on the ME-V timing unit, see Fig. 31. In January 2016, because such a root cause analysis was not produced by Pepperl & Fuchs, we decided to stop specifying the Pepperl & Fuchs sensor as an alternative on the ME-V timing units. Presently, we therefore only have one sensor alternative, Contrinex, for the feedback sensor on the ME-V timing unit.



Fig. 31: Mechanical damage on Pepperl & Fuchs.

G & S50ME-B9.3 Timing Unit Piston Design Modification

We have upgraded the design of the ME-V timing unit piston on G and S50ME-B9.3 engines. The upgrade was carried out to improve the high-pressure oil's access under the timing unit piston, see Fig. 32. If unsatisfactory actuation of the timing unit pistons is reported, the new modified pistons are supplied to the vessel. Normally, the timing unit pistons can be exchanged by the engine crew onboard the vessel.

Multi-Purpose Controller (MPC) Quality Issue

In general, failure rates of electronics follow the so-called "bathtub curve" shown in Fig. 33. During the first period, typically the first year when the product is under warranty, relatively high failure rates, sometimes referred to as "infant mortality", are experienced. Weak parts are replaced during this period, followed by a period with low failure rates, and ending with an increase in failure rates towards the end of the product lifetime.

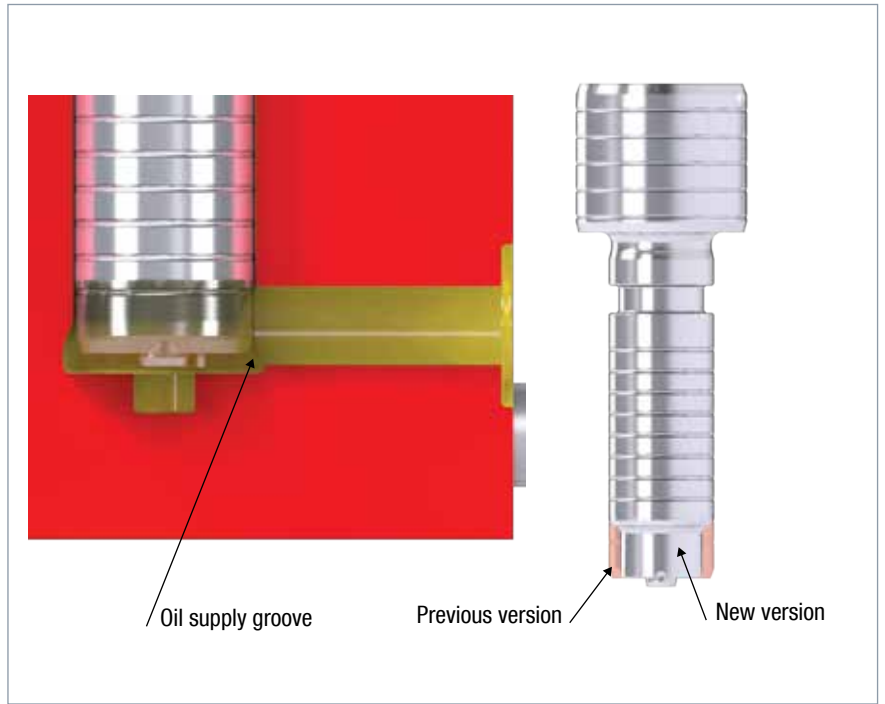

Fig. 32: Improved design of the ME-V timing unit piston

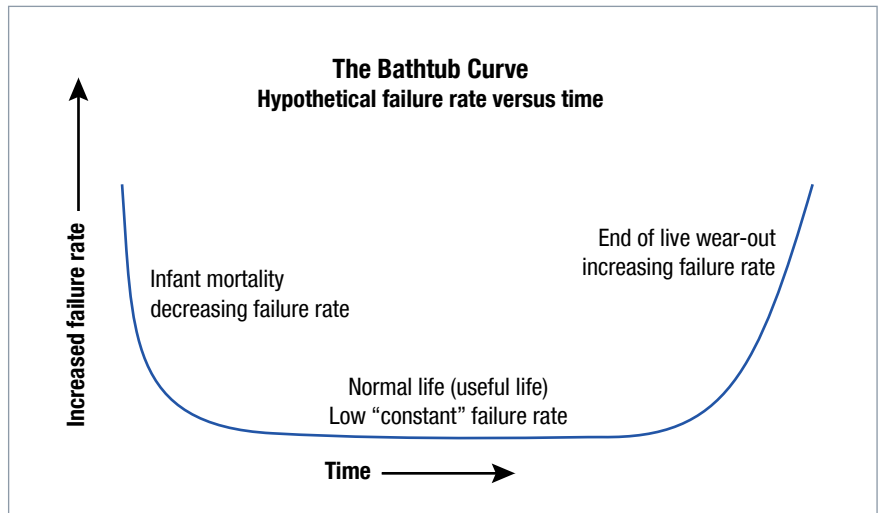

Fig. 33: Failure rates of electronics in general

We have experienced that MPCs and MPC10s, see Fig. 34, from one of our electronic manufacturing service (EMS) providers have suffered too high failure rates extending into the normal lifetime of the product. This means that high return rates are experienced also after the guarantee period. This high failure rate was analysed at the EMS in question in a production stop period during the first half of 2015. The production processes were rectified and then re-started.

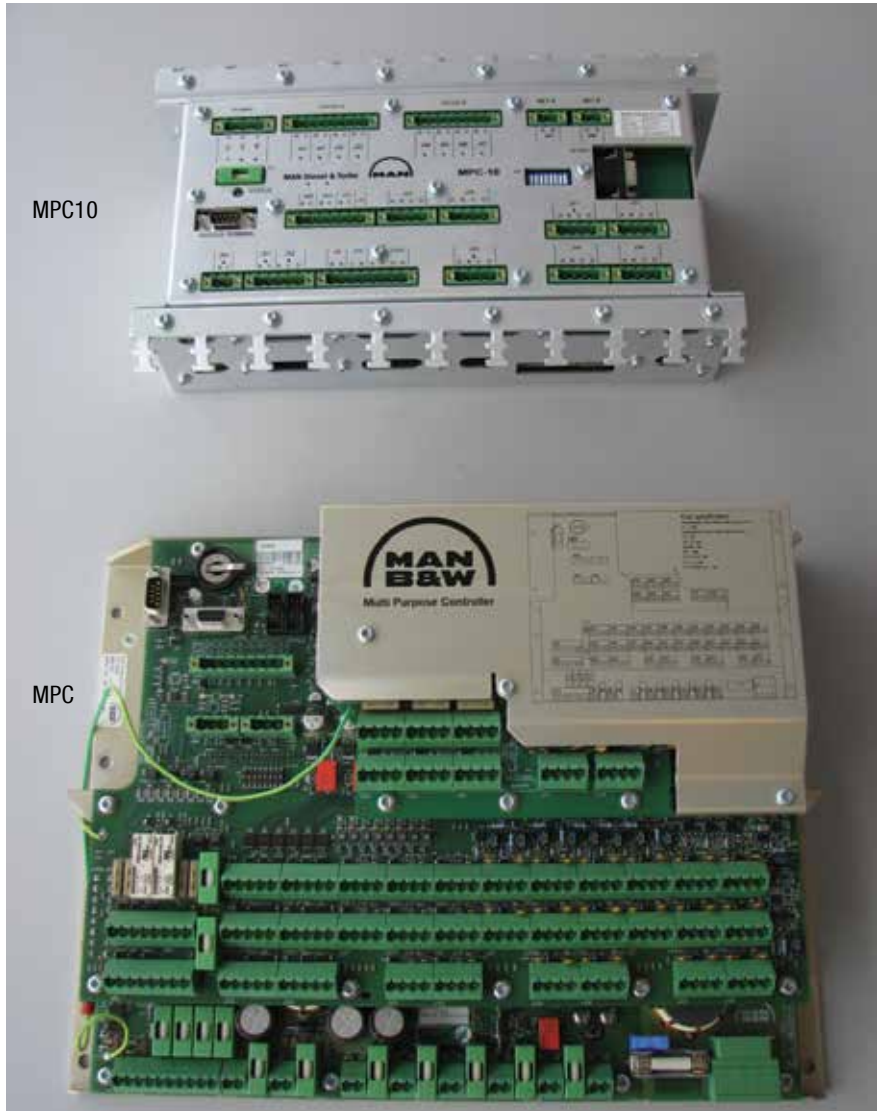
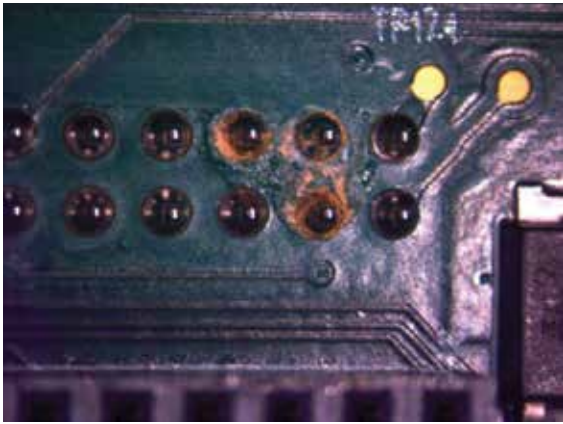
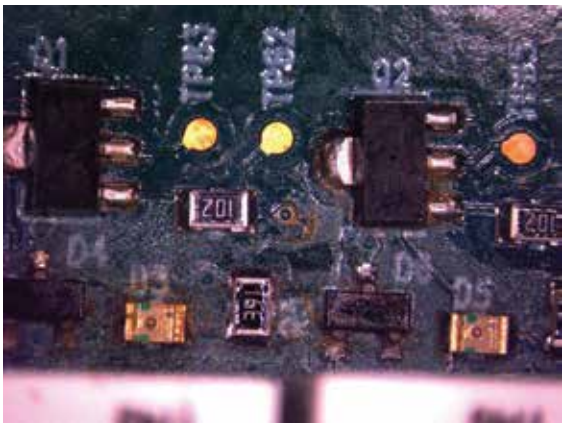

Fig. 34: MPC and MPC-10



MPC 340 CPU (OT0772)



MPC 350 IO (OT0772)

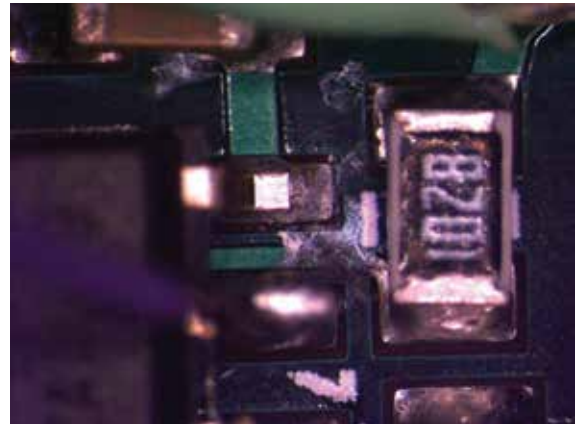

MPC 0360 IO board (OT0391)

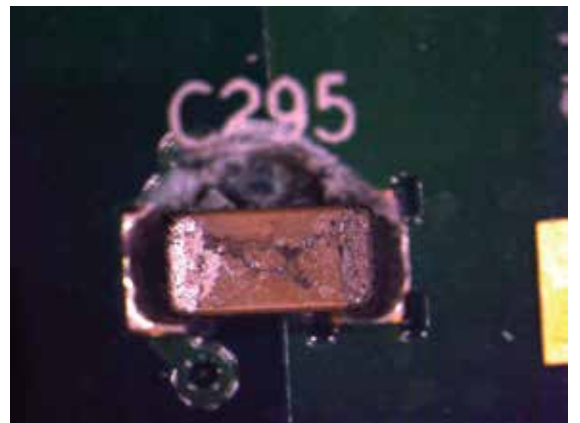

MPC10 850 IO board

Fig. 35: Flux residues on MPC/MPC10

Fig. 36: Electrochemical migration

During the analysis of the production processes, flux residues were found on both the top and on the bottom sides of the PCBs, see Fig. 35. The presence of the flux residues may result in electrochemical migration (ECM). Investigation of returned (failing) MPCs and MPC10s confirmed that when exposed to moisture, electrochemical migration had taken place. The result is short-circuiting of various components on the PCB, which again results in malfunctions of various kinds. Fig. 36 illustrates two ex-

amples of electrochemical migration on the MPC's IO board.

We have negotiated an extension of warranty for MPC/MPC10s from the EMS involved. This extension includes two years on top of the standard one-year warranty. The warranty is valid independent of who has been the contract partner with the EMS, and irrespective of whether the product has been purchased through a licensee or through MAN Diesel & Turbo.

System Oil Cleanliness on ME-C/ME-B Engines

The FIVA and ELFI valves consist of a pilot valve stage and a main valve stage, see Fig. 37. In some cases, the pilot spool in the pilot valve has suffered from rather high wear during short running hours. This results in early wear-out and, eventually, an excessive leakage amount. Fig. 38 shows the pilot valve spool wear after a short time of operation.

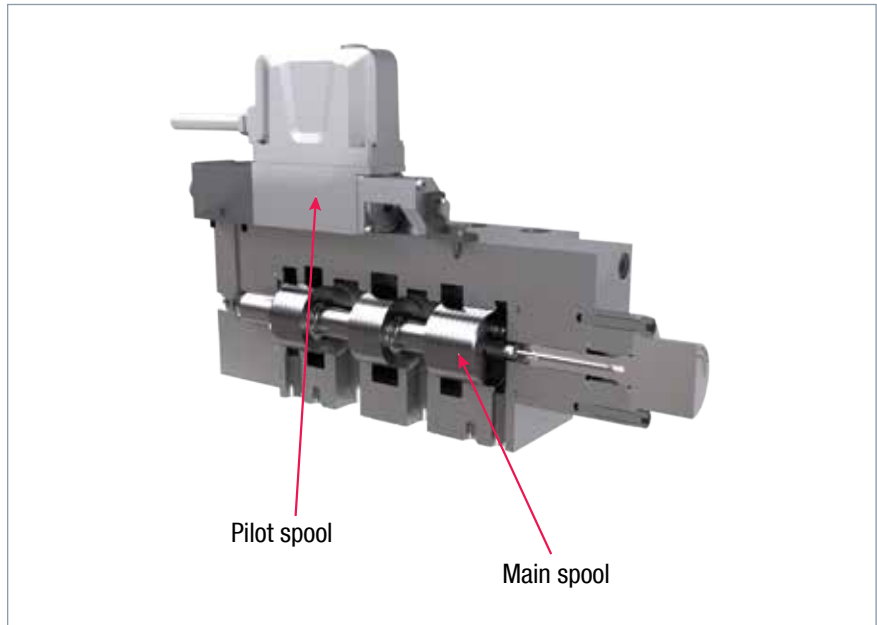

Fig. 37: MAN B&W FIVA valve

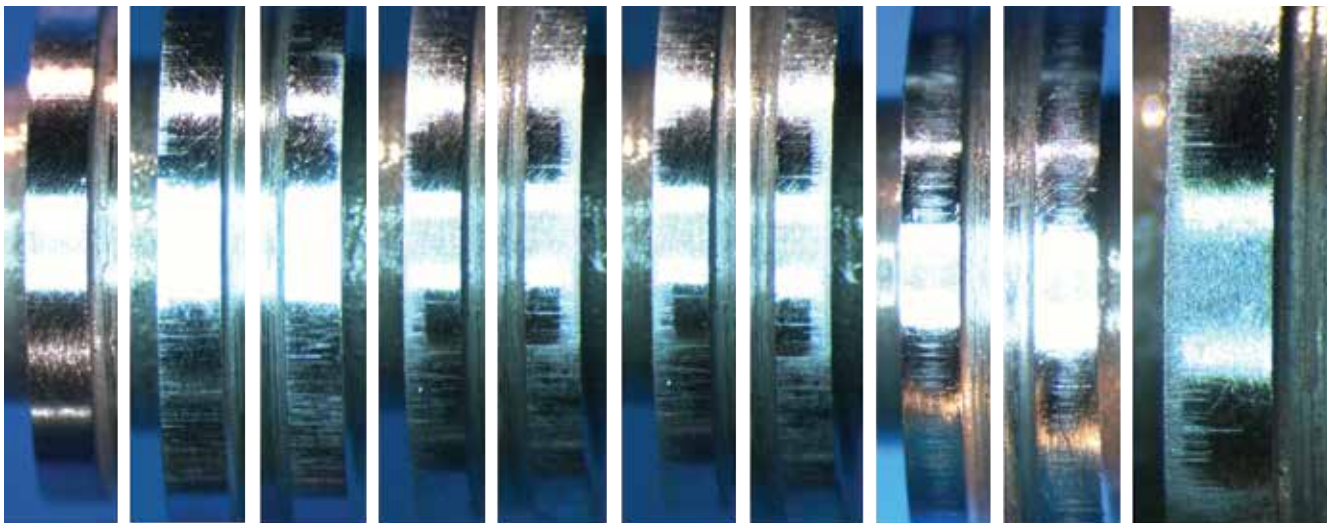

Fig. 38: Pilot valve spool wear

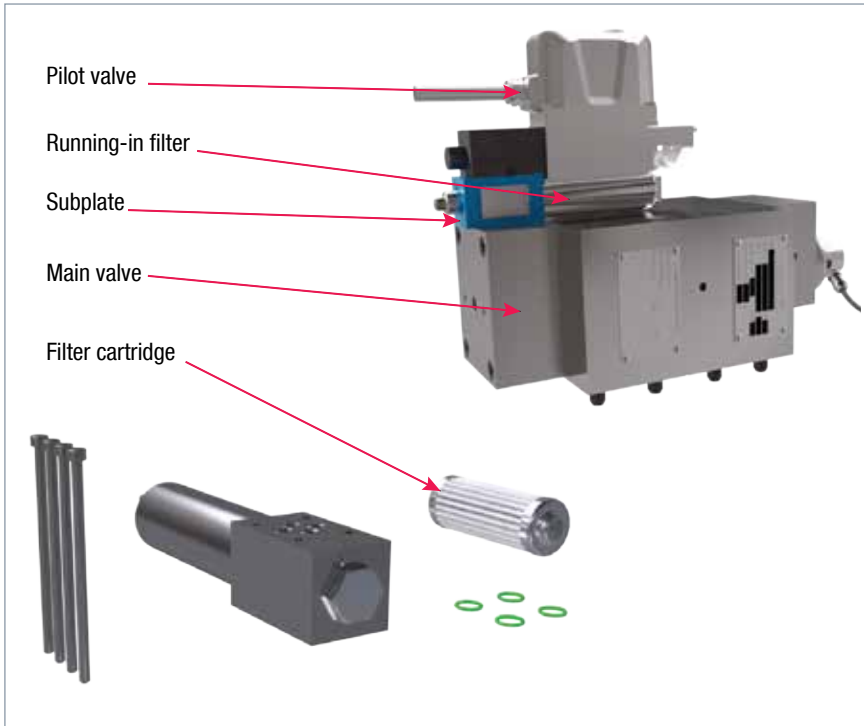

Fig. 39: Running-in filter applies during shop test and sea trial

Typically, the pilot valve spool wear occurs early during the commissioning period at the shop test and/or during sea trial, where the system oil is relatively dirty. We therefore prescribe a running-in filter to be installed between the main stage and the pilot stage of the FIVA valve, see Fig. 39. The running-in filter is removed again after the commissioning period when the engine enters into service. The filter cartridge is replaced before the running-in filter is re-used.

When checking the system oil used on the ME system for cleanliness level, we define the acceptable level according to the cleanliness code ISO4406/XX/16/13. In this relation, we recommend testing the cleanliness level of the system oil with regular intervals. However, we do not recommend using the laser method for particle counting. We recommend using a method for particle counting that is based on microscopy analysis disregarding “non-particulate contaminants”.

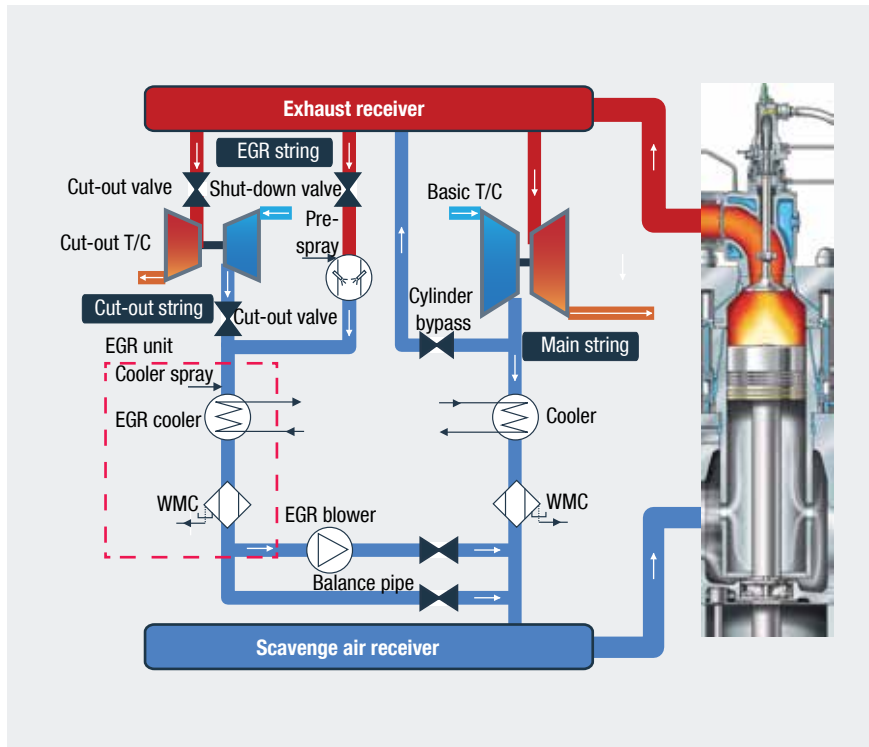

Fig. 40: EGR T/C cut-out matching

Tier III Service and Test Experience

Exhaust gas recirculation (EGR) is available in two different versions. For engines with one turbocharger the cylinder bypass solution is used, whereas T/C cut-out matching is applied for two or more turbochargers, see Fig. 40. Most service experience has so far been obtained with the T/C cut-out solution.

In January 2016, some 4,000 running hours with EGR were obtained, when counting both prototype testing and testing in service. Most of these EGR running hours were performed on high-sulphur fuel oils with only around 200 hours on low-sulphur fuels.

As of January 2016, the following vessels and engine plants fitted with EGR (all high-sulphur EGR systems) are in service:

- Container vessel with 6S80ME-C9
 - approx. 3,000 EGR hours on HSFO (high-sulphur fuel oil).
- Two oil tankers with 6G70ME-C9
 - approx. 2 x 500 EGR hours on LSFO (HSFO EGR system, but running only on LSFO).
- Oil tanker with 6S60ME-C8
 - limited EGR running hours.

Late in 2015, cylinder oil sweep tests with HSFO were carried out successfully onboard the container vessel with a 6S80ME-C9. These tests indicated a small cylinder oil consumption penalty in the Tier III running-mode, see Fig. 41. In other words, we are able to control the cold corrosion level in Tier III running mode.

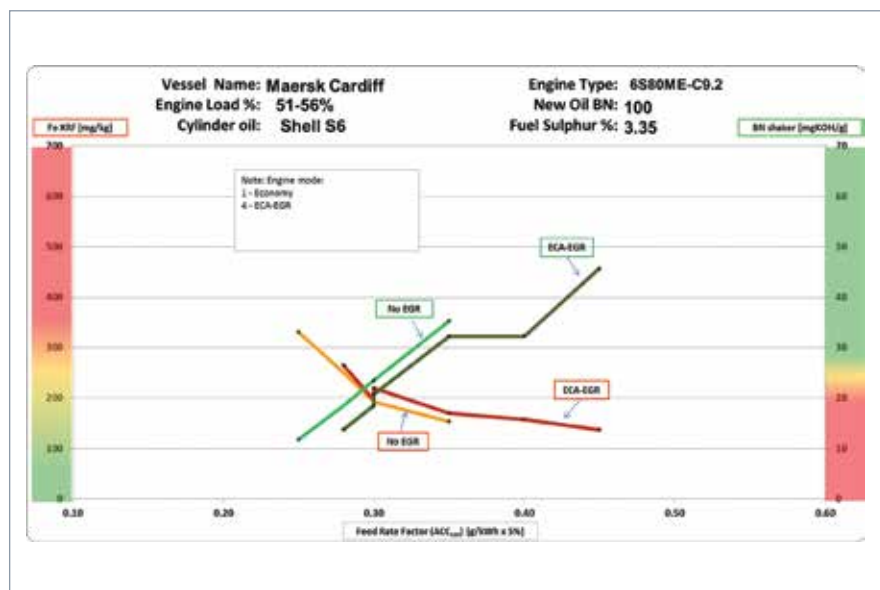

Fig 41: Cylinder oil sweep test on 6S80ME-C9 engine with EGR

In order to find ways to lower the initial cost of EGR, a number of material tests are ongoing, both on the 6S80ME-C9 and on the vessels with the 6G70ME-C9 type.

Human errors and the supervision concept of the water treatment system (WTS) have led to a breakdown of coolers on the 6S80ME-C9, see Fig. 42. Most likely, the cause is a combination of chlorides and an extremely low pH-value. The supervision concept will be revised for future plants.

We expect that deposits and build-up of dirt will be much less widespread when running on LSFO. Initial service experience seems to confirm this ex-

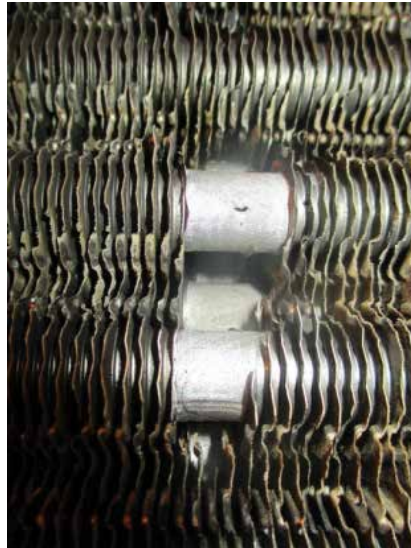

Fig 42: Damaged and corroded air cooler

pectation when comparing a 6G70ME-C9 on LSFO with a 6S80ME-C9 on

HSFO. Figs. 43 and 44 illustrate the difference for the EGR mixing chamber.

The water treatment system (WTS) on the vessel with a 6S80ME-C9 has reached the maker's recommended overhaul time (three years or 6,000 running hours), and all seals have been replaced in all separators. A new WTS strategy is being tested on a 6G70ME-C9 for the LSFO plants. We call it partial cleaning concept, and this concept will be tested on a 6G70ME-C9 during 2016. With the present Tier III zones around USA and Canada, the main focus will be on LSFO operation with EGR in the near future.



Fig. 43: Mixing chamber on a 6G70ME-C9 (LSFO operation)



Fig. 44: Mixing chamber on a 6S80ME-C9 (HSFO operation)

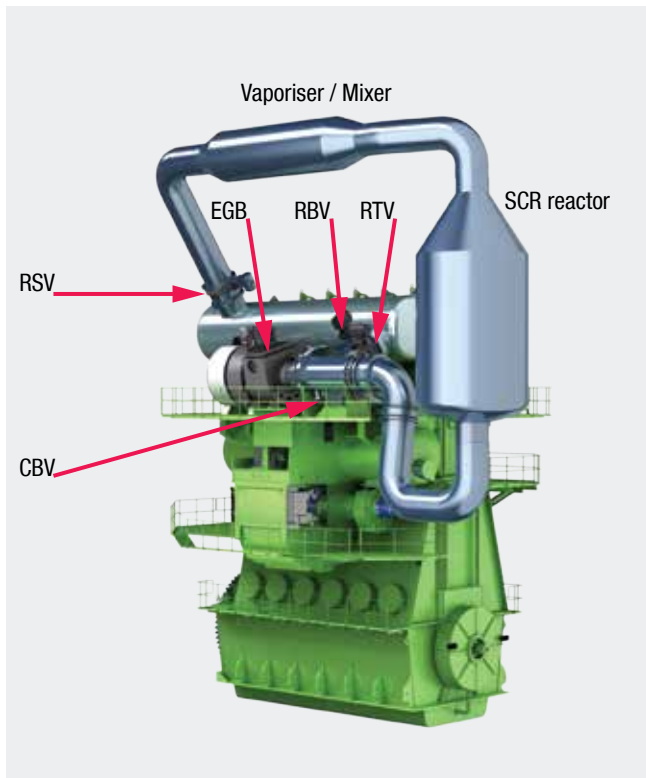

Fig. 45: High-pressure SCR system

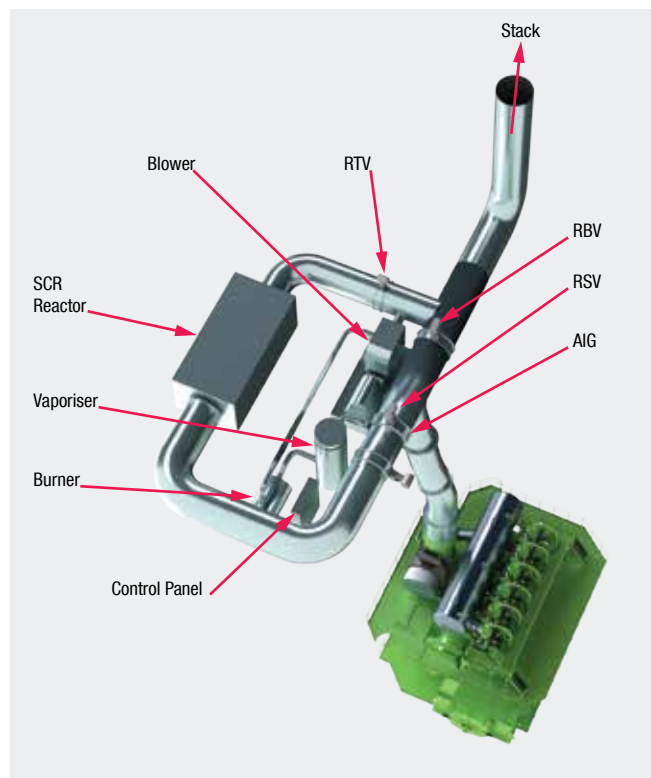

Fig. 46: Low-pressure SCR

Selective catalytic reduction (SCR) is the alternative method to EGR for Tier III compliance. SCR comes in two versions. One version is the high-pressure SCR system, see Fig. 45, where the exhaust gas is “denoxed” before the turbocharger. This system can operate on HSFO. The other version is the low-pressure SCR system, see Fig.

46, where the exhaust gas is cleaned downstream of the turbocharger.

An order for 6S50ME-C8.2 engines with high-pressure SCR installation was shop tested at the end of 2015, and entered service in 2016. This order comprises a series of three engine plants with high-pressure SCR and SO_x

scrubbers. All three vessels will enter service in 2016 and operate continuously on high-sulphur fuel.

Low-pressure SCR has been tested on a 6G60ME-C9.2 engine in Korea. An engine with this system will enter service towards the end of 2016.

ME-GI Service Experience

The gas channel pressure sensors installed in the gas blocks, see Fig. 47, have undergone some development. The first version of this sensor could not be ATEX approved and a preliminary solution with an electric barrier had to be used on the first engines in service. The first version of an ATEX approved gas channel pressure sensor was too sensitive in relation to engine vibrations. At the time of writing, new versions of ATEX approved sensors are being tested.

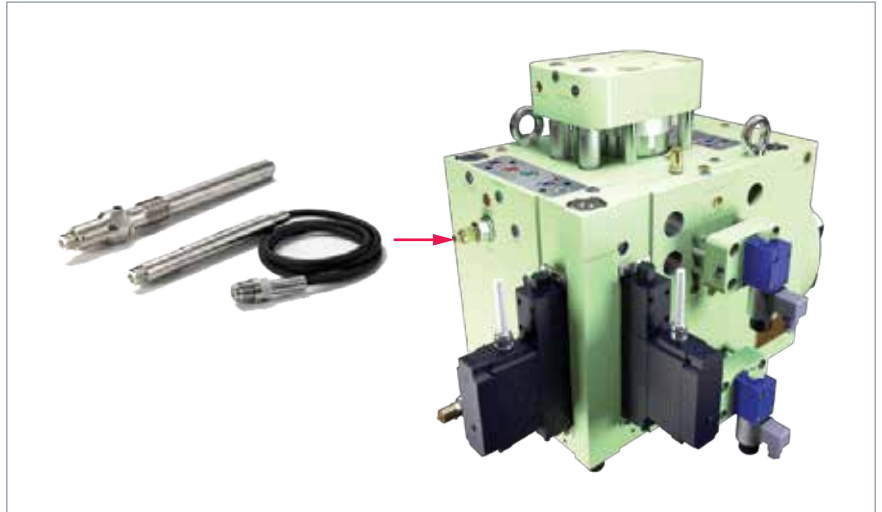

Fig 47: ME-GI commissioning experience – gas channel sensors

A booster pump has been installed in the low-pressure oil supply line to improve venting of air in the control oil bores after engine standstill. On the first two engines in operation, the first installation had to be modified by supporting the electric motor with brackets and reducing vibrations from the pipe connections by means of rubber compensators, see Fig. 48.



Fig 48: Modified LPS pump arrangement

The gas injection valve has been updated on the outside geometry of the spindle guide to improve the guidance during installation in the cylinder cover. This update will protect the gas injection seals during installation of the gas injection valve. Fig. 49 illustrates the changed outside geometry of the spindle guide.

Furthermore, a seal has failed in service due to lack of back-up. The trouble is caused by too large a conical machining, resulting in the lack of back-up for the seal. A temporary solution consisting of a seal with a steel back-up ring, see Fig. 50, is in use until new complete gas injection valves can be installed.

Dirt in the pipes between the fuel gas supply system (FGSS) and the gas valve train (GVT) has caused the small 10-micron filter in the GVT to block up frequently during commissioning and during first operation in service. Larger filters with back-up are being designed at the time of writing. The specification in our project guides for gas engines says that maximum 5-micron solid particles can be accepted. More care should be taken in flushing the gas-pipes at the commissioning stage. Furthermore, an increased cleanliness of the LNG fuel bunkered is required.

We have experienced high vibration levels of the helix part of the gas supply pipes. New updated wire mounts and X-bracket supports have been applied to reduce vibrations to satisfactory levels, see Fig. 51.

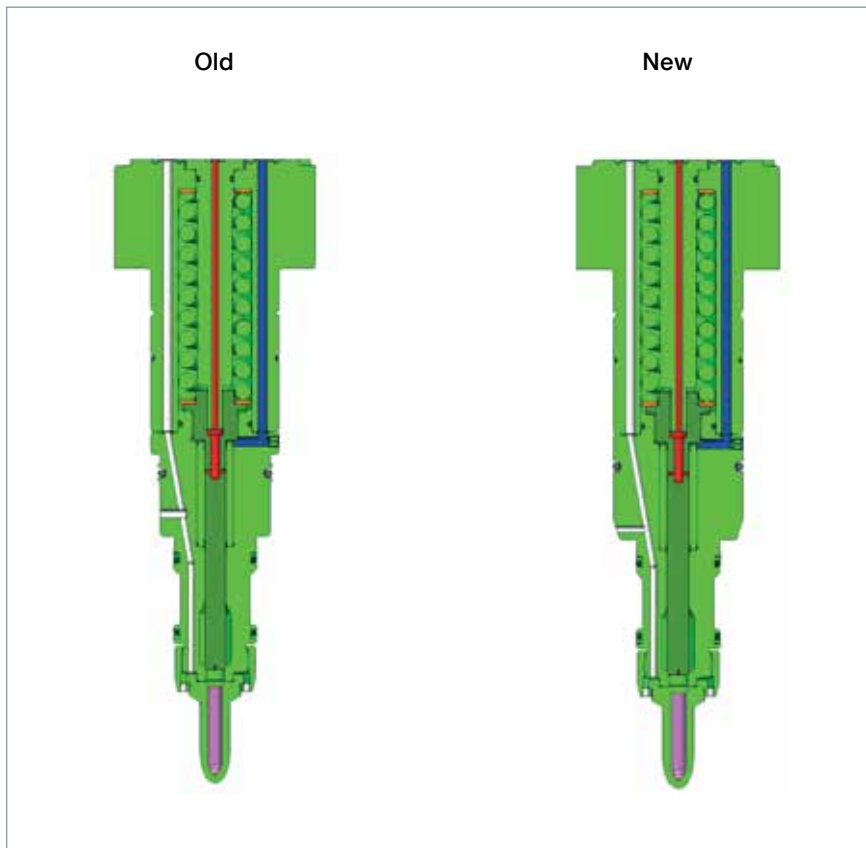

Fig 49: Updated outside geometry of spindle guide

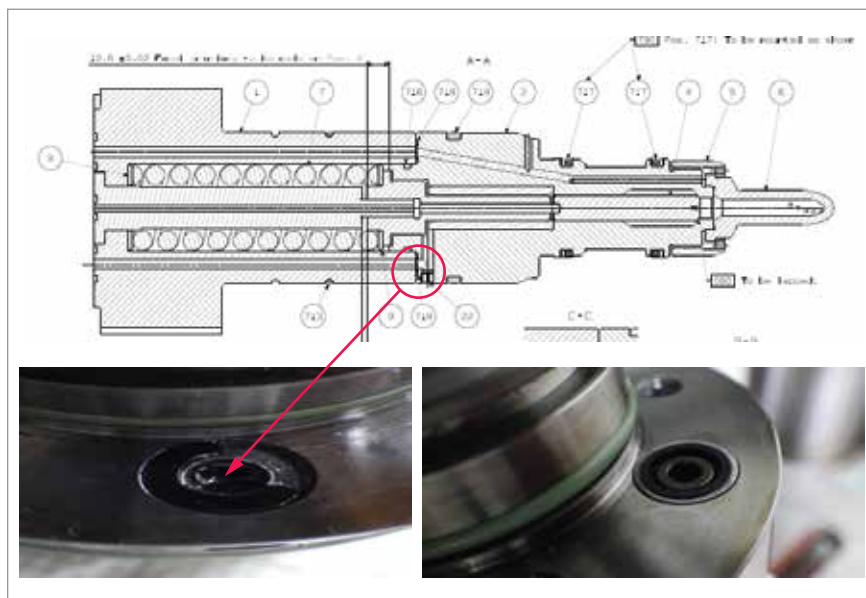

Fig 50: Temporary solution – seal with a steel back-up ring

Conclusion

This paper outlines the recent issues related to the service experience gained over the last 2-3 years with MAN B&W two-stroke engines. We have described the service experience by discussing various principle topics, and by focusing on a number of case stories.

It can be concluded that cold corrosion of cylinder liners is now under control. Further development is in progress to ensure that this control is maintained also when entering the era of fuels with very large variations in fuel sulphur content, not least when applying various gaseous fuels in combination with pilot fuels of various kinds.

Recent acceleration issues experienced, mainly due to the EEDI legislation, have also been solved by specifying higher propeller light running margins as well as introducing a transient operation mode called dynamic limiter function (DLF).

Tier III service experience as well as the first service experience with ME-GI engines has been touched upon.

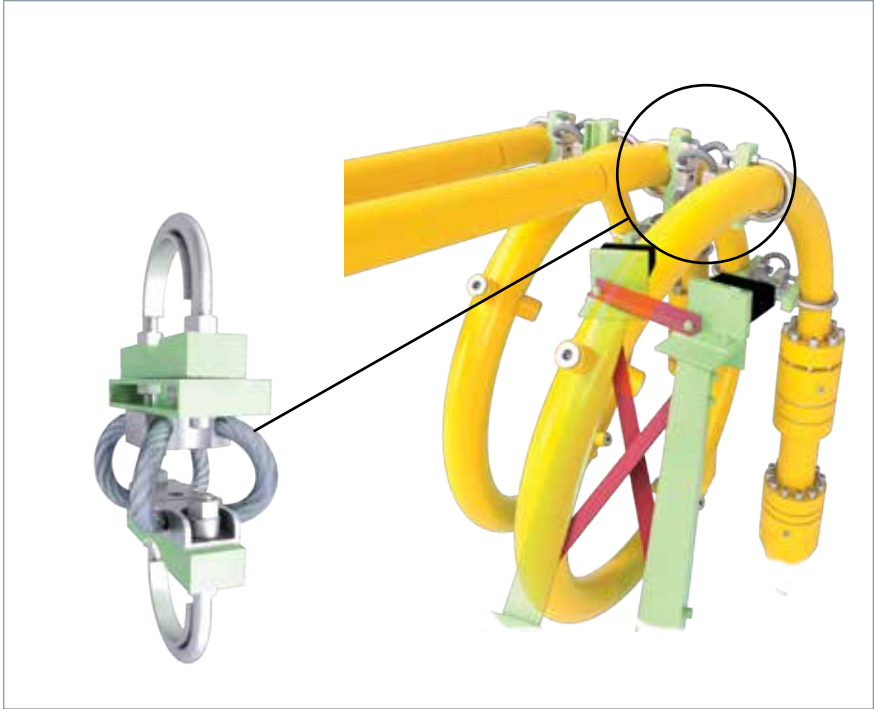

Fig 51: New updated wire mounts and X-bracket support for helix pipes

All data provided in this document is non-binding. This data serves informational purposes only and is especially not guaranteed in any way. Depending on the subsequent specific individual projects, the relevant data may be subject to changes and will be assessed and determined individually for each project. This will depend on the particular characteristics of each individual project, especially specific site and operational conditions. Copyright © MAN Diesel & Turbo. 5510-0195-00ppr Jul 2016 Printed in Denmark

MAN Diesel & Turbo

Teglholmmsgade 41
2450 Copenhagen SV, Denmark
Phone +45 33 85 11 00
Fax +45 33 85 10 30
info-cph@mandieselturbo.com
www.mandieselturbo.com