



Service Experience

Two-stroke Engines

Engineering the Future – since 1758.

MAN Diesel & Turbo



Contents

Introduction	5
Quality of ME Electronics (Hardware and Software)	5
Time Between Overhaul (TBO) for ME-Engines	8
Optimised Low-load Operation for ME Engines	10
Operation on Low-sulphur Fuels	12
Second Order Moment Compensator Bracket Crack Case.....	13
Cylinder Condition Update – Small Bore Engines	16
Cylinder Condition Update – Large Bore S-type Engines	19
Case Story: Jumping Fuel Injectors on S50ME-C with 300-bar Hydraulic System	22
Case Story: Breakage of High-pressure Fuel Pipes on 6S80ME-C Mk 9	23
Design – Production – In-service Cycle for MAN B&W Two-stroke Engines ..	25
Conclusion.....	27

Service Experience – Two-stroke Engines

Introduction

This paper outlines the status on the service experience gained from MAN B&W two-stroke engines of the electro-hydraulically controlled ME/ME-C types, and gives an update of the service experience on MC/MC-C types with camshaft control. 2011 saw a remarkable shift towards ME engines after the introduction of the IMO Tier II rules. Today, nearly 50% of all MAN B&W two-stroke engines ordered are of the ME type.

In the large-bore segment (80, 90 and 98-cm bore), close to 100% of new orders are for ME versions. It is therefore of extreme importance that the ME engine has reached a matured development status, and this paper confirms that this is indeed the case.

Today, the ME engine concept is widely accepted among major shipowners, and the benefits of electronic control are increasingly being acknowledged as the concept is enhanced with features such as auto-tuning, integrated control of exhaust bypass, variable turbine area turbochargers, turbocharger cut-out and, in the near future (Tier III era), integrated control of exhaust gas recirculation, water-in-fuel emulsion and SCR.

Optimisation of operation at low load is also dealt with. Both fuel consumption and cylinder oil consumption can be improved by various retrofit packages.

Also, so-called classic operational issues, which are naturally still of utmost importance, are described in the two case stories.

Quality of ME Electronics (Hardware and Software)

Since the introduction of MAN B&W two-stroke ME engines in regular service some 7-8 years ago, the electronic hardware and software of the engine control system (ECS) have seen substantial quality improvements. In many cases, the initial versions of electronic hardware for the ME engines experienced too high failure rates. This has led to changes to various sensor types, control valve electronics, main operating panels (MOPs), multi-purpose controllers (MPCs) as well as cabling and connectors. Historically, there are a number of different reasons for these changes, and some of them can be listed as follows:

1. Stronger vibrations/shocks than initially specified
 - on hydraulic cylinder units (HCUs) and exhaust valves
2. Higher temperatures than initially specified
 - on fuel boosters
3. Many failures caused by bad cable-connectors
 - on sensors and control valves
4. Some cases of installation failures
 - electro-static discharge (ESD) and bad cabling
5. Many “no failures” cases
 - on returned product.

Various corrective actions have been taken for sensors and control valves, and improved approval procedures for new products/suppliers have been introduced. During the design phase of new or updated electronic parts, the so-called highly accelerated life testing (HALT) is now being widely used on the electronic ME products. HALT is a test in which the electronic parts are exposed to extreme vibration levels in combination with extreme heat cycling.

The test continues until the failure of an electronic component on the part. In this way, the weakest point of the electronic part is identified, and this may then form basis for a design review.

For new or modified electronic parts and for new suppliers of electronic parts, the following tests are carried out before release to production:

- Functional tests
- Type approval tests
- Extended vibration tests
- Service tests.

We have introduced quality checks by way of highly accelerated stress audit (HASA) tests in the current production of electronics parts. HASA tests will cycle vibration and temperature during a predetermined period (e.g. 24 hours) at realistic, but somewhat elevated, heat and vibration loads in order to sort out weak electronic parts before they are used in the engine production. In addition, for MPCs, a burn-in test of the full production volume has been introduced in order to connect and run the MPC at

various temperatures. In this way, also weak MPC's are sorted out. This test will typically run over a 14-hour period, see Fig. 1.

For sensors and control valves, we have integrated the cables to get rid of cable connectors. Instead, we use the simple and much more reliable conventional junction boxes to join cables and electronic parts.

As mentioned above, the MPC is one of the components for which too high return rates have been reported. Reports from one Asian electronics manufacturing services (EMS) provider indicate that these return rates are now under control, see Fig. 2. L1, L2 and L3 are three different engine builders.

The same EMS provider has analysed the returned MPCs and found that nearly half of them had no failures, see Fig. 3. Also, we have often received back electronic and electro-hydraulic parts that had no failures when checked in our laboratory. The reason for this is often a poor possibility of doing qualified troubleshooting when a failure has been experienced on board a vessel with an ME engine. The initial versions of the ECS software did not give the crew on board many possibilities for locating the failing electronic or electro-hydraulic part. In many cases, this has resulted in the return of parts which had no failures.

We have now released new ESC software with much improved troubleshooting possibilities available on the Main Operating Panel (MOP). The improvements can be summarised as follows:



Fig. 1: Burn-in test of MPCs

- Commissioning screen for the hydraulic cylinder units (HCU)
- Commissioning screen for the tacho system
- Commissioning screen for the hydraulic power supply (HPS)
- Troubleshooting screens for HCUs and HPS
- Data loggers for HCUs and HPS
- Export of HCUs and HPS data logger data to Excel
- ECS isolation monitoring and alarms
- Electrical noise monitoring and alarm
- Alarm improvements, grouping of related alarms.

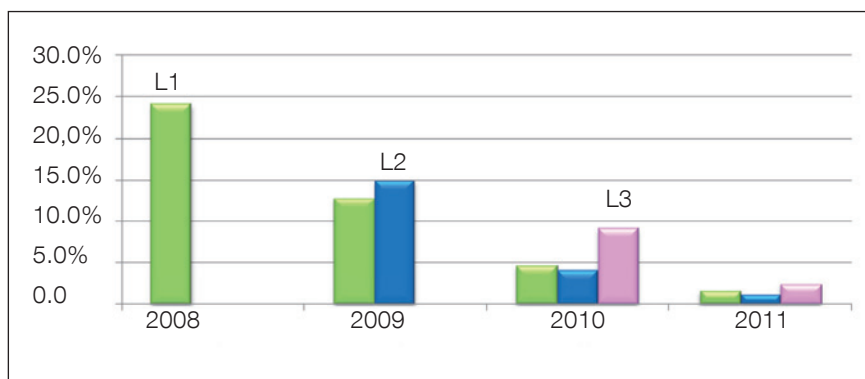

Fig. 2: Return rates of MPCs from our EMS provider

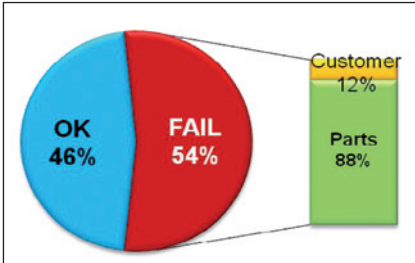

Fig. 3: Analysis of returned parts

Examples of troubleshooting screens and data-logger screens are seen in Figs. 4 and 5. Fig. 4 shows the troubleshooting screen for the hydraulic cylinder unit (HCU), and Fig. 5 shows the data-logger screen for the HCU, the so-called “HCU Events”. The data-logger continuously records predetermined signals related to each HCU at high frequency (2 kHz), and storage is triggered by an event, typically an alarm. Data from just before the event and from just after the event can then be analysed on board, exported to Excel and further analysed on board or ashore.

We are presently installing the new improved ECS software on all vessels in service with ME engines. All new ME engines will, of course, also have the new improved ECS software.

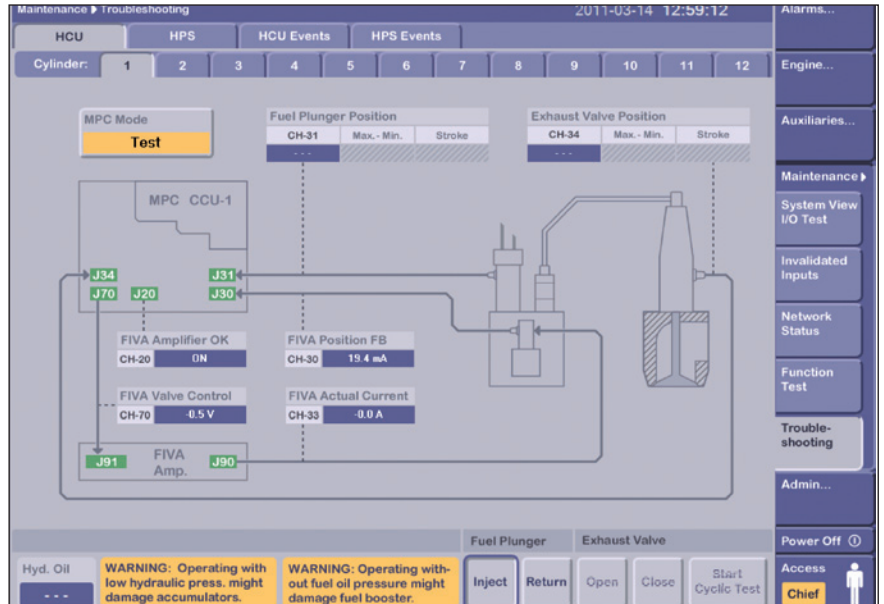

Fig. 4: HCU troubleshooting screen

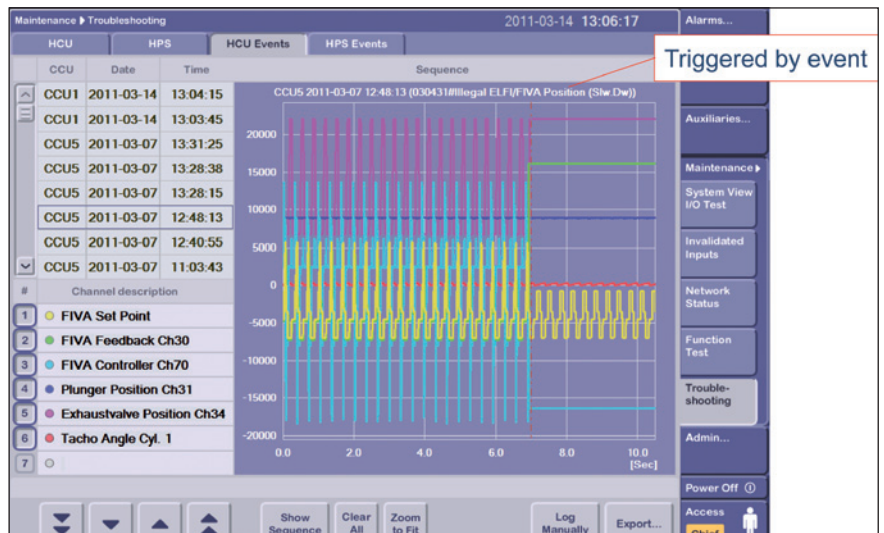

Fig. 5: HCU event data logger

Time Between Overhaul (TBO) for ME-Engines

In April 2009, we issued new updated guiding overhaul intervals for all our MAN B&W two-stroke MC and ME engines. For the first time, we included the hydraulic and electronic components for the ME engines on these lists. We could do this as the ME engine design had been matured sufficiently to predict overhaul intervals for the new components on these engines. This initiative also indicates that ME engines as such have reached a matured design status. The guiding overhaul intervals for the hydraulic components are shown in Table 1.

A very central part of the ME system is the main hydraulic pumps in the hydraulic power supply (HPS). For these pumps, we can confirm that an over-

haul interval of 32,000 hours is possible. After this time of operation, the pump bearings must be exchanged and, in some cases, also other interior parts of the pumps may need renewal. The overhaul can either be carried out on board the vessel or in workshops ashore.

Recent experience with the main hydraulic pumps indicates that more than 32,000 hours between major overhaul can be obtained. This will require inspection on board to evaluate the wear condition of one of the pumps and then set up a sequential overhaul of the pumps one by one. Fig. 6 shows the

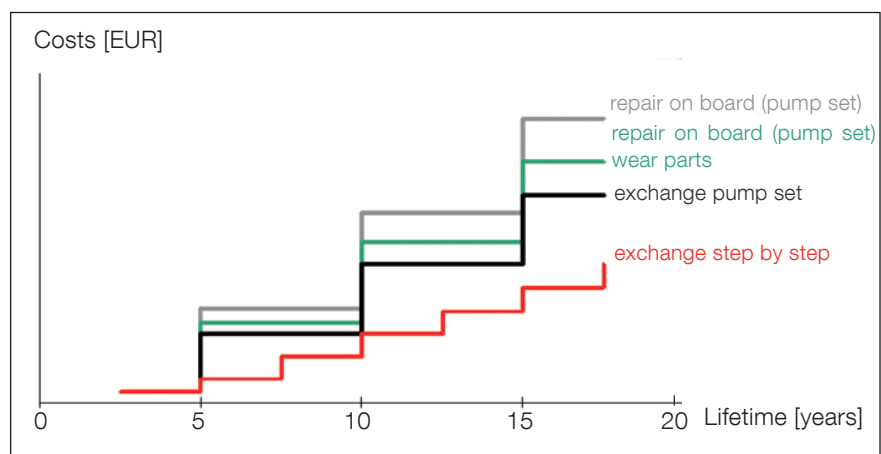

Fig. 6: Alternative overhaul strategies for main hydraulic pumps for ME engines

ME-B engines – guiding overhaul intervals and expected service life

Component	Overhaul interval (hours)	Expected service life (hours)	Remarks
Main hydraulic pump	32,000	Engine lifetime	Check and replace hydrostatic bearings at overhaul. Check and replace cylinder set and piston if required.
Proportional valve for main hydraulic pump		20,000	Replace valve after 20,000 hours
Pressure relief valve for main hydraulic pumps	40,000	Engine lifetime	Replace sealings at overhaul
Exhaust valve actuator	32,000	Engine lifetime	Replace static sealing rings at overhaul.
ELFI valve	32,000	64,000	Check and replace if required
Fuel valve	8,000 - depending on fuel quality	Valve nozzle 16,000 Spindle guide 16,000	Check and replace if required
Fuel oil pressure booster	32,000 - based on engine observations	64,000 Replace or recondition	Change piston rings on hydraulic piston and suction valve at overhaul.

Table 1: Guiding overhaul intervals for hydraulic ME components

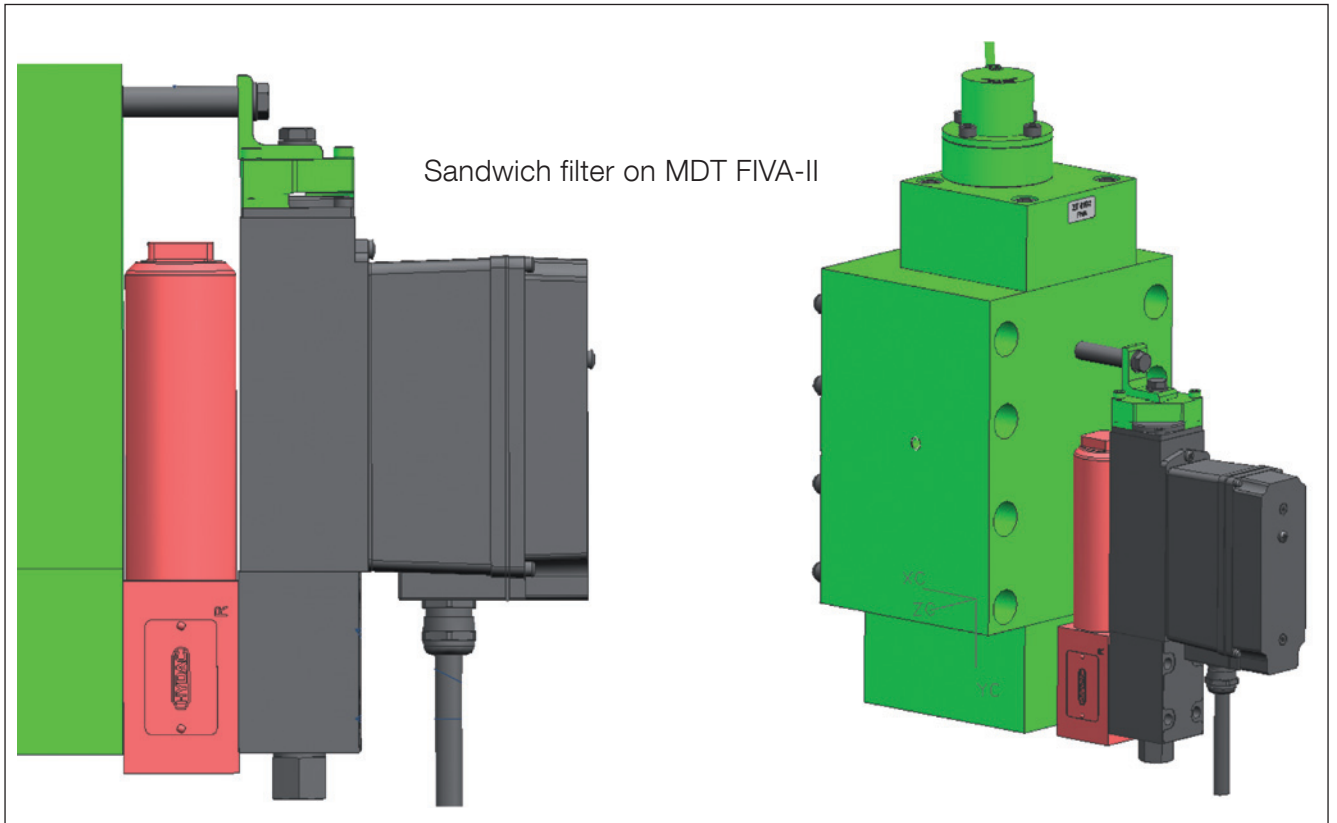

Fig. 7: MDT FIVA valve with sandwich filter mounted

original overhaul regime (black) compared with the latest “step-by-step” approach (red).

Another central part of the ME system is the fuel injection valve actuation (FIVA). For the FIVA valve, we also state 32,000 hours between overhauls. In order to reach this interval, we need to protect the pilot valve from dirt in the hydraulic oil during commissioning. We are presently testing so-called sandwich filters installed during commissioning at the engine builder and at the

shipyard. These filters will be dismantled before vessel delivery. In this way, we will be able to obtain 32,000 hours between exchange of the pilot valve. The pilot valve can be exchanged on board by the ship's crew. Fig. 7 shows the FIVA valve with a sandwich filter installed. The main valve is green, the sandwich filter is red and the pilot valve is dark grey.

Optimised Low-load Operation for ME Engines

Since the worldwide financial crisis developed in the second half of 2008, low-load operation or slow steaming has been the standard of the day for many owners operating MAN B&W two-stroke engines. In the early days of slow steaming, mainly container vessel operators requested to operate at low load. Today, also operators of tankers, bulkers, etc. are beginning to operate continuously at low loads.

In late 2008, we issued a service letter dealing with continuous low-load operation down to 40% load and, in

May 2009, we were ready to officially support continuous low-load operation down to 10% load. Since then, nearly all service experience with continuous low-load operation has been positive. The application of fuel injection valves of the slide type has been very important to this success. Slide-type fuel valves significantly reduce fouling of the exhaust gas ways, especially when operating at low loads.

Soon after, it became normal to operate engines at extremely low loads, and the request to optimise low-load running surfaced. This can be supported in two

ways on MAN B&W two-stroke engines:

1. Increase the scavenge air pressure at low and part load
2. Reduce the cylinder oil feed rate at low load.

Most elegantly, this is supported on the electro-hydraulically controlled ME-engines. The ME engine control system (ECS) is designed to control the variable turbine area (VTA) turbocharger, exhaust gas bypass (EGB) and flexible turbocharger cut-out systems.

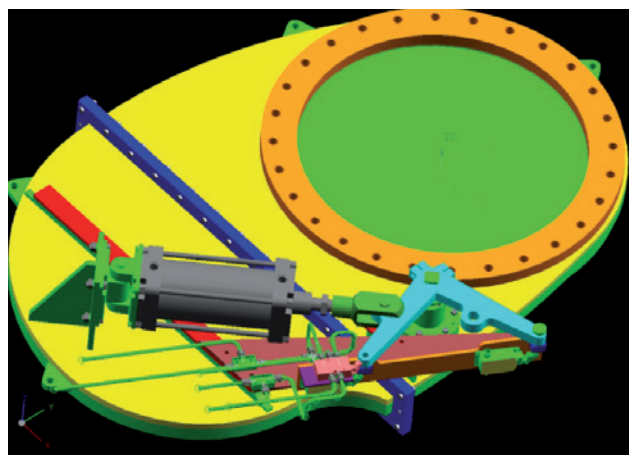

Fig. 8: Swing gate valve for flexible T/C cut-out

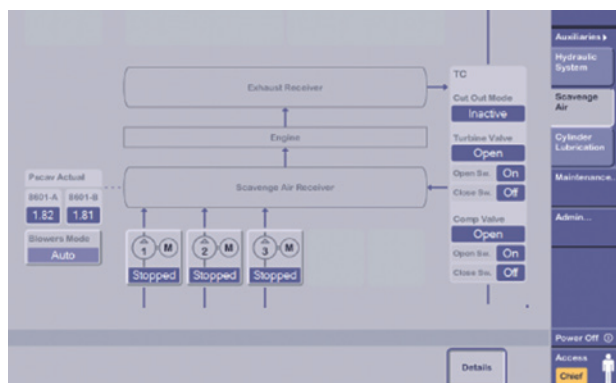
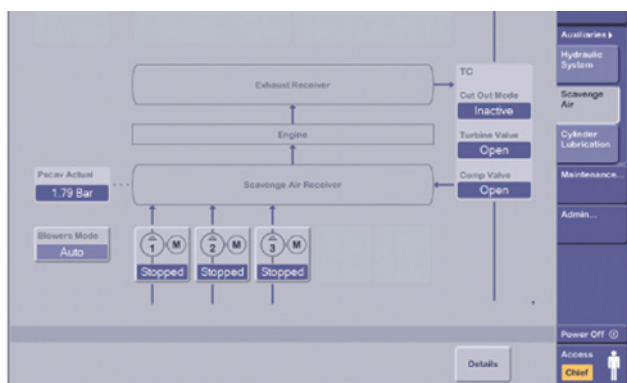

Fig. 9: T/C cut-out MOP screens

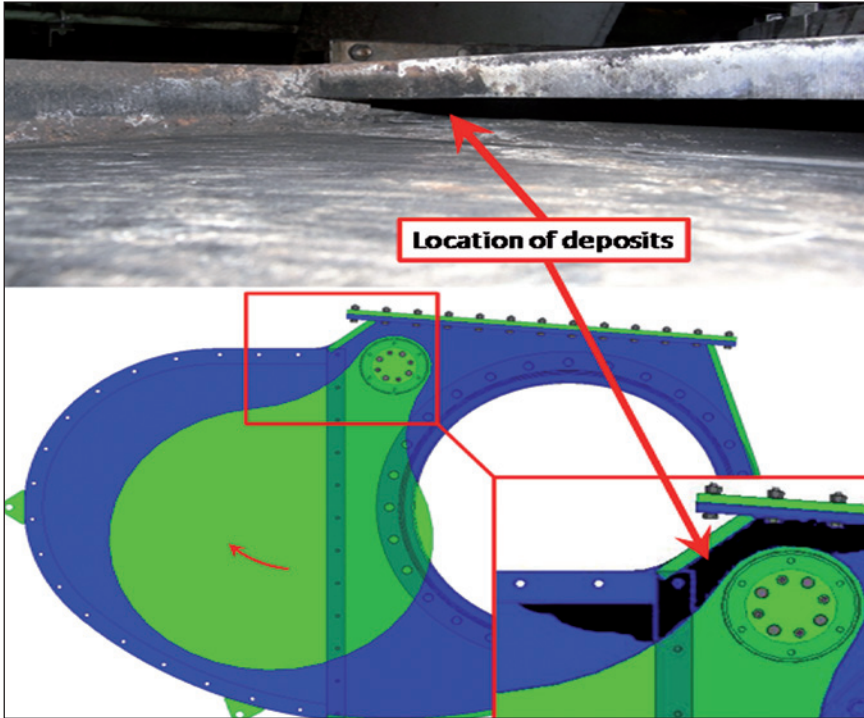

Fig. 10: Carbon deposits on the swing gate valve on the turbine side

For engines in service, the flexible turbocharger cut-out system with control of the so-called swing gate valves has become a retrofit solution often applied on engines with two, three or four turbochargers. Fig. 8 illustrates this design, in principle and in reality, on the compressor side of a K98ME engine. Fig. 9 indicates how the T/C cut-out mode is implemented with a separate view on the MOP.

For the swing gate valve on the turbine side, accumulation of combustion deposits has been seen as shown in Fig. 10. Cleaning instructions have therefore been included in the service manual to ensure the correct functioning of the valve.

Today, optimisation of the cylinder oil feed rate is also requested for extreme low-load operation in the load range

from 25% and down to 10%. Service experience on this issue is dealt with in our latest service letter on low load operation from June 2011. We have

tested this on several engines with very good results, running load-proportional lubrication reduction of the cylinder oil feed rate all the way down to 10% load. In this way, it is possible to save half the cylinder oil at loads in the range of 10-15%. This is illustrated in Fig. 11.

For ME engines, this changed adjustment can be accomplished simply by making parameter changes in the ME ECS software. For mechanical engines with Alpha Lubricators, rebuilding of the lubricators is required.

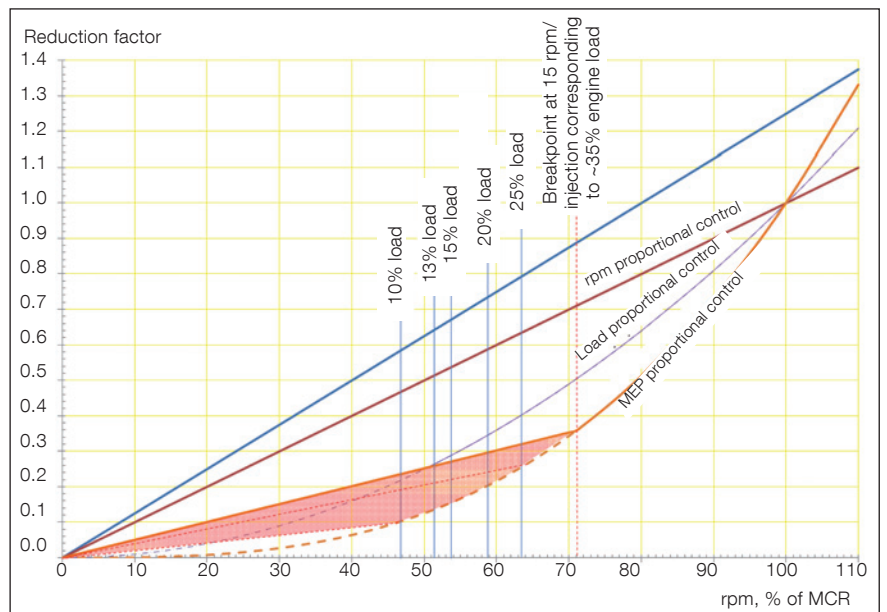

Fig. 11: Cylinder oil feed rate reduction with breakpoint at various loads

Operation on Low-sulphur Fuels

Lately, more experience has been gained on operating on low-sulphur fuels in two different areas:

1. Low-sulphur heavy fuel oils (HFO)
2. Low-sulphur distillates.

For low-sulphur HFOs, the most important issue is the increased number of catalytic fines seen in average when bunkering HFOs with a low sulphur content, see Fig. 12. This fact will put even more focus on optimal fuel treatment on board vessels with efficient use of the purifiers installed.

Furthermore, correct design of fuel tank systems is important. We are currently updating our recommendations on this issue, which in future will also be included in the project guides.

Experience with operation on distillates has mainly been gained in the SECA area on the American West Coast. Various statistics on the impact of operation on distillates in this area have been published. An office under the California Air Resource Board (CARB), the Office of Spill Prevention and Response (OSPR), has presented data on so-called loss of propulsion (LOP) incidents. Fig. 13 shows a recently published statistic on LOP incidents at the Californian ports from January 2004 to August 2011. This statistic shows an increase of yearly LOPs at the same time as the fuel sulphur content was decreased in California. It is stated that this increase is caused by so-called fuel switching LOPs. There is a lot of debate on whether this statistic reflects the use of lower sulphur fuel, or if it is also related to a changed way of counting LOP incidents over the years. However, from an engine designer's point of view, we

can only repeat our recommendations already given in our service letters:

1. Before entering congested areas where fuel switching is required, it is highly recommended to test start and reversing performance outside the congested area.
2. Performance checks must be conducted in order to verify the wear condition of the fuel pumps. If the fuel index has increased by 10% or more compared with the test bed condition, the fuel pumps must be overhauled to ensure correct performance on distillate fuel.
3. In case very low viscosity distillates are used, a fuel oil cooler needs to be considered in order to ensure a viscosity of min. 2 cSt at the engine inlet.

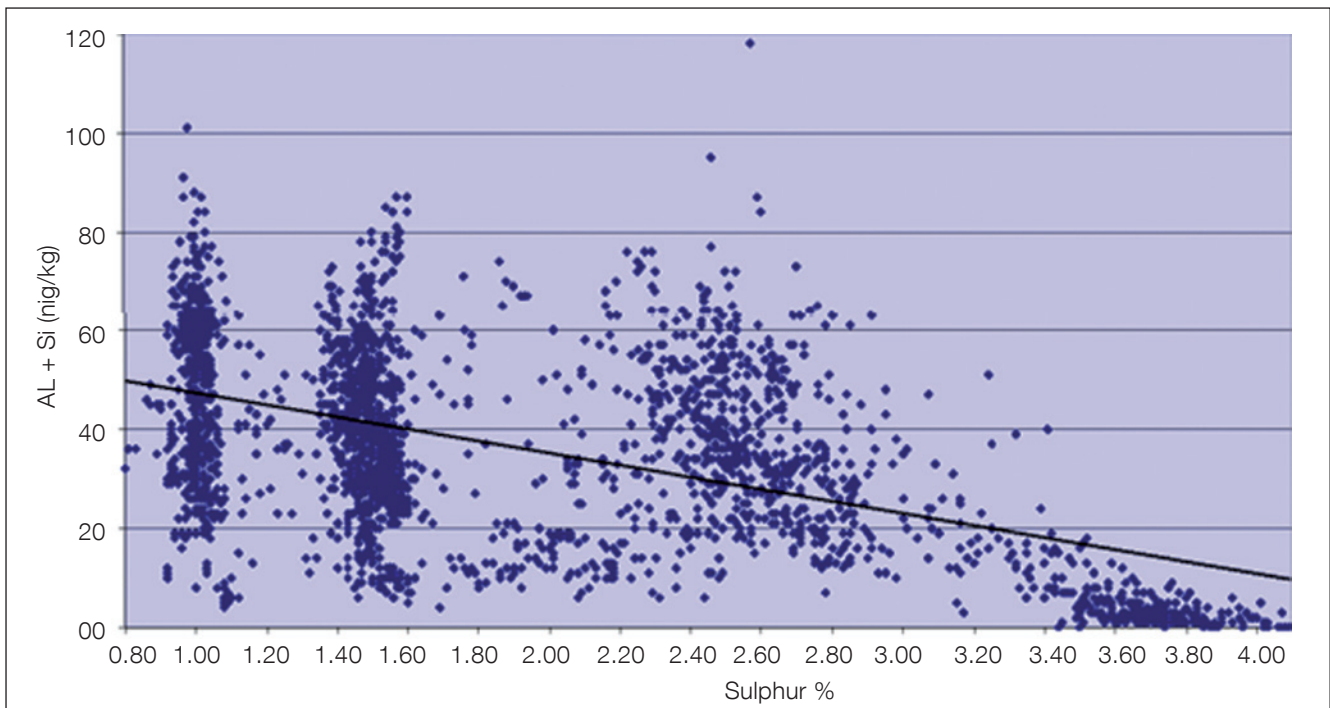
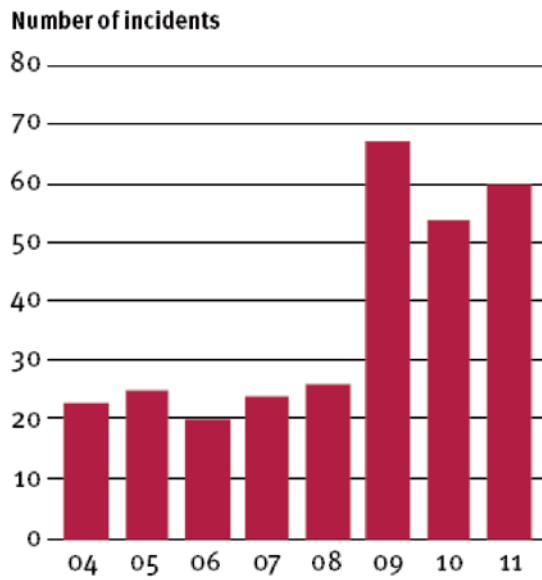

Fig. 12: Cat fines in bunker fuel (source: DNVPS)

LOSS OF PROPULSION INCIDENTS January 2004 to August 2011



Source: US Coast Guard

Fig. 13: Loss of propulsion incidents – California Ports. In 2009, a cap on fuel sulphur content was introduced in California waters

It should be mentioned that not one single incident of fuel switching LOP has been recorded with our ME engines whereas other types of electronically controlled engines are represented.

Second Order Moment Compensator Bracket Crack Case

The biggest single guarantee case ever in relation to MAN B&W two-stroke engines is the second order moment compensator bracket crack case. Fig. 14 shows a typical crack. When this case was discovered for 60/70ME-C/MC-C engines in late summer 2010, we immediately communicated this to all licensees involved. We also took immediate initiative to perform a design review, and based on this review, we subsequently updated the design with an action code covering all engines not yet delivered. In cooperation with all licensees involved, and with the assistance of especially PrimeServ-Korea, we managed to avoid putting further vessels in service without the updated design. The previous and updated designs are shown in Fig. 15.

In parallel with the design review, we issued a Circular Letter to owners with the critical design in service. The aim of this Circular Letter was:

1. To ensure that engines with cracks were identified so that the planning for rectification could be initiated in cooperation with the operators. Many of the vessels affected are tankers and postponement until scheduled docking is preferable.
2. To get more statistics on the number of cracks and, thereby, evaluate the criticality of the design variations.

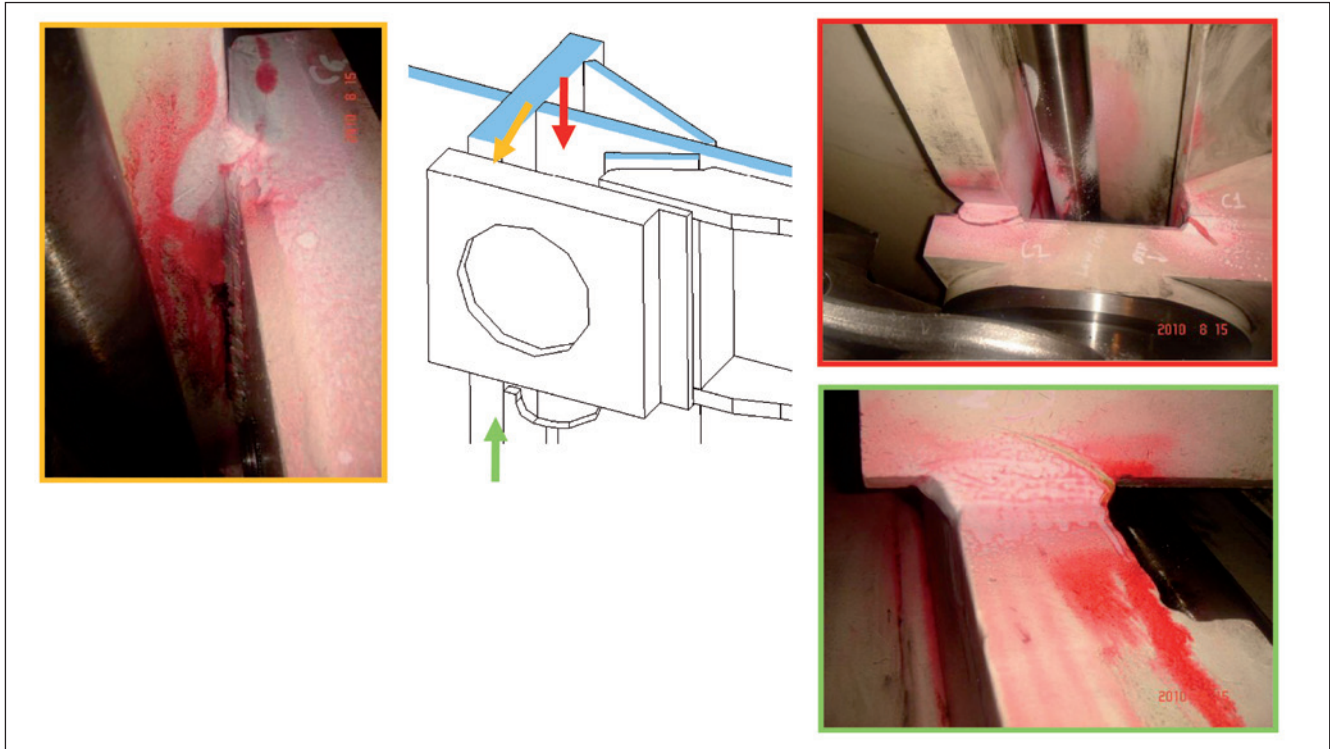

Fig.14: Example of crack in bracket carrying a second order moment compensator

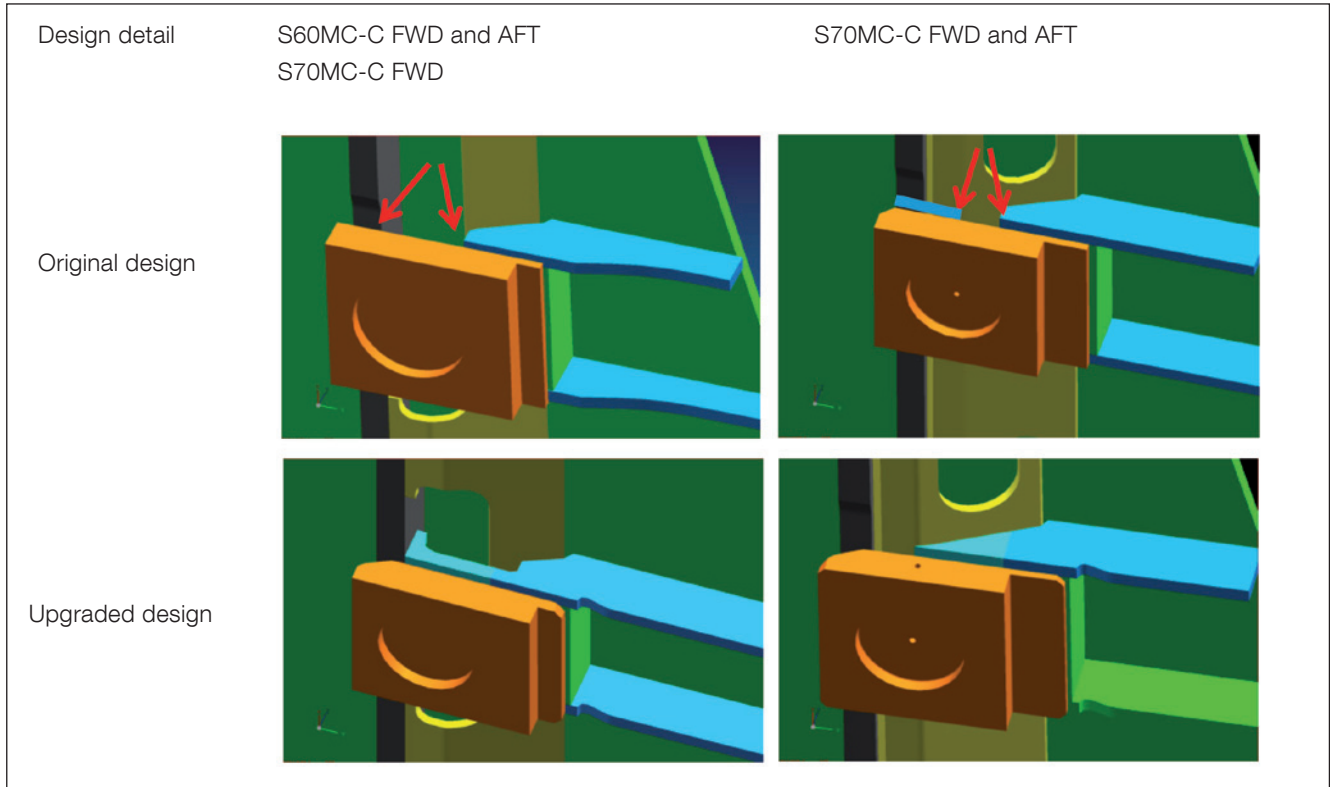

Fig. 15: Modification of bracket design

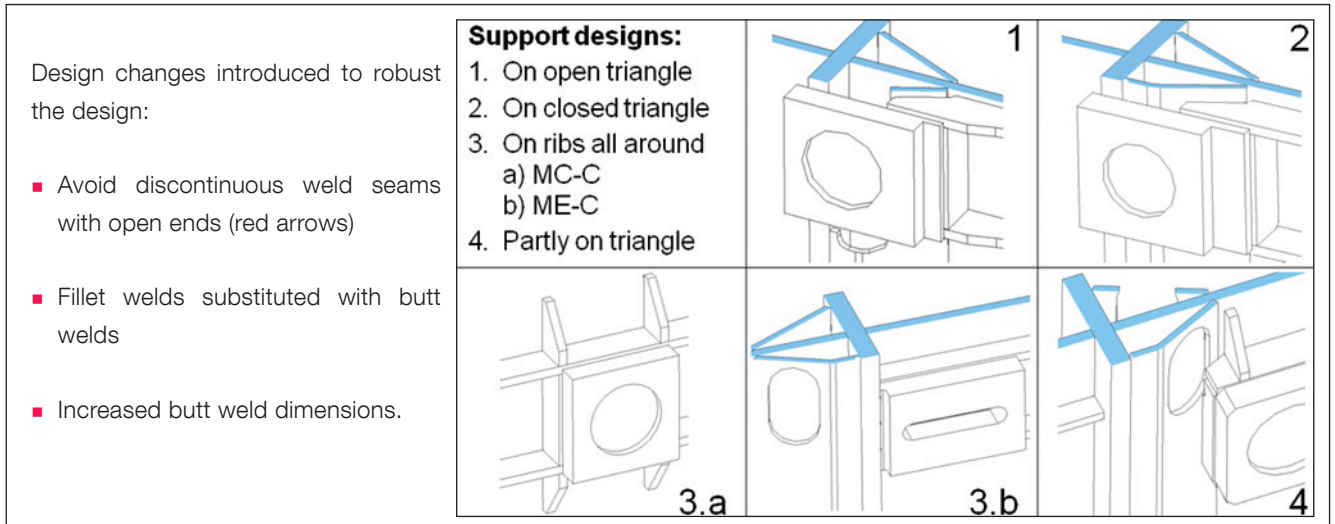

Fig. 16: Design variants in service

At the end of 2011, we were ready to slightly modify our plan of action for the update of engines in service. In another Circular Letter, the designs were categorised in four variants, see Fig. 16.

Based on feedback from service, we now concentrated preventive rectification on variant No. 1, support on open triangle. The 2011 Circular Letter also specified an inspection scheme for the first 18,000 hours of operation. There is no need for rectification (also for design variant No. 1) after 18,000 hours of operation without crack formation. We also specify inspections during the first 18,000 hours after a welding rectification in order to ensure that the rectification has been successful.

At the beginning of 2012, we discovered cracks in the second order moment compensator bracket on an S50MC-C engine type. Fig. 17 shows an example of these. The designs of the S50MC-C and S46MC-C engines had already been updated in June 2011 based on experience gained in the meantime with 60 and 70-cm bore

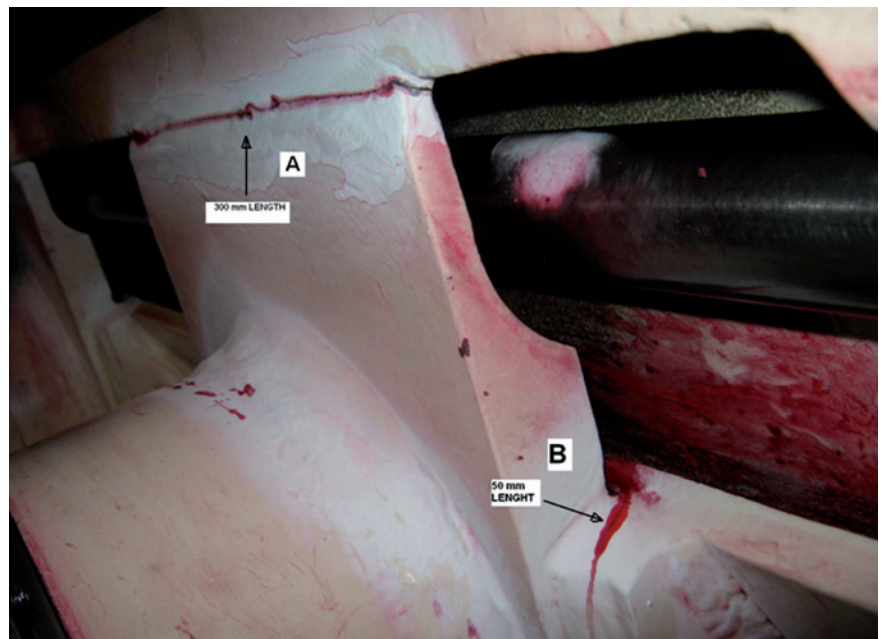

Fig. 17: S50MC-C: crack in second order moment compensator bracket

engines. However, this was done on a weak action code, and at most engine builders it had not taken effect in the production at the beginning of 2012.

Therefore, a new design update note (DUN) with a harder action code has been released, specifying modification instructions for all S46/50MC-C/ME-C under production. At the time of writing,

vessels in service are being inspected in order to determine the final and proper countermeasure in each case.

Cylinder Condition Update – Small Bore Engines

For some years, small bore engines have been specified with our well-proven alu-coated CPR piston ring pack, see Fig. 18. However, in some cases on small bore engines, this has resulted in limiting overhaul intervals by wearing out the CL-grooves of the top piston ring.

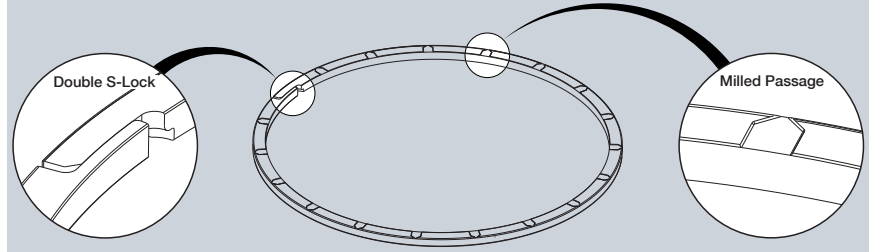

Fig. 19: Port-on-plane (POP) top piston ring design

If complete wear out of the CL-grooves on the top piston ring occurs, the pres-

sure drop will often be so large that adhesive wear between liner and ring will be the result, and the risk of damage to the liner surface will be a consequence.

The CPR (controlled pressure relief) ring pack with CL-grooves (controlled leakage grooves) was introduced on all MAN B&W engines at the turn of the century. This design change resulted in a significantly improved overall cylinder condition resulting in increased TBO.

Main advantages include better distribution of the pressures across each ring and elimination of the problem with overheating and collapse of the second ring.

1998 Alu-coat	
	1st ring: CPR Base material: Vermicular cast CV1 Run-in coating: 0.3 mm alu-coating 6Cl groove, Pos. 45, 90, 135 deg. 2.0 mm wide, 5.5 mm deep
	2nd ring: Left cut Base material: Grey cast CF5 Run-in coating: 0.3 mm alu-coat
	3rd ring: Right cut Base material: Grey cast CF5 Run-in coating: 0.3 mm alu-coat
	4th ring: Left cut Base material: Grey cast CF5 Run-in coating: 0.3 mm alu-coat

Fig. 18: Alu-coated CPR piston ring pack

The port-on-plane (POP) top piston ring, Fig. 19, will have the opposite characteristics. As the top ring wears, the relief ports will increase the leakage area and, thereby, the pressure drop across the top ring will decrease. This will reduce the contact pressure between the top piston ring and the cylinder liner, and also reduce piston ring wear. The POP top piston ring has a stabilising influence on piston ring wear. This is opposite to the conventional CPR ring, which is basically unstable. For small bore engines, this is an important difference giving the new POP piston ring pack a longer lifetime.

The introduction of the POP ring pack is based on the service experience gained on the 6S40ME-B prototype engine. At first glance, the cylinder condition looks very satisfactory after 10,000 hours of operation, see Fig. 20. Also, the cylinder liner wear is very satisfactory, see Fig. 21. All liners inspected have wear rates below 0.05 mm per 1,000 hours.

However, when looking more closely on the wear condition of the top piston ring, it can be seen that unit No. 1 is very near the wear limit due to the CL-groove depth reduction, see Fig. 22.

We now specify the POP ring pack for this engine type. We have accumulated more than 230,000 service hours on various engine types with the POP rings. One of the service tests has been carried out on all cylinders on a

6S46MC-C engine. After 6,735 hours, the width of the port opening had increased by 1.1 mm, corresponding to a top piston ring wear of 0.55 mm, see Fig. 23. With a wear potential of 2.7 mm, wear-out is estimated to happen after approx. 33,000 hours. Due to the self-stabilising nature of the POP ring, as described above, the estimated lifetime of 33,000 hours is conservative. We can expect even more running hours before wear-out occurs.



Fig. 20: Scavenge port inspection of prototype 6S40ME-B at 10,000 hours

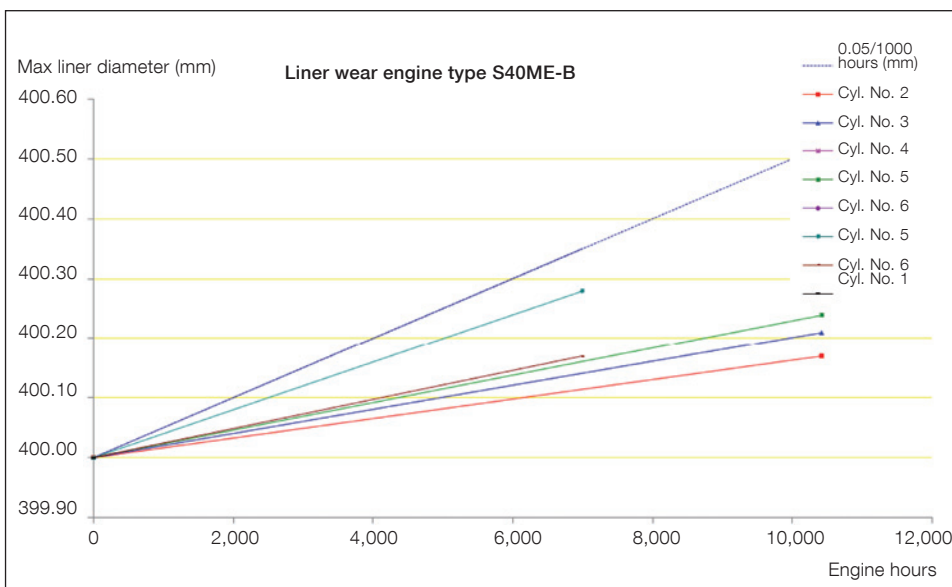

Fig. 21: Cylinder liner wear: 6S40ME-B at 10,000 hours

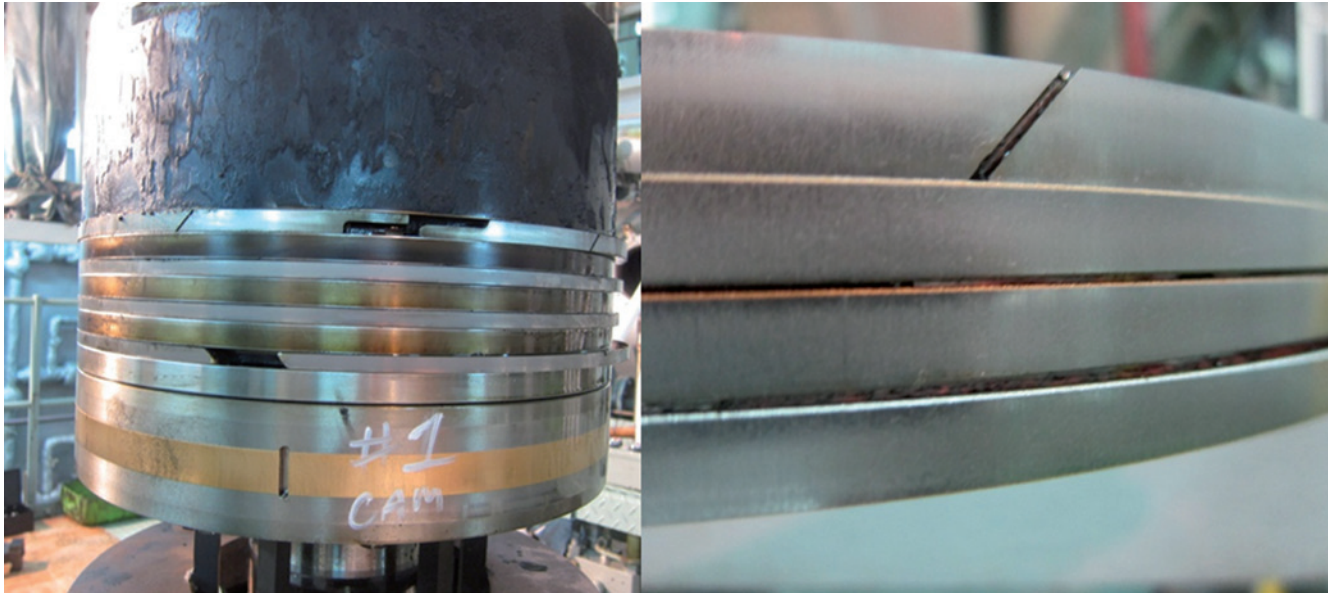

Fig. 22: Piston rings indicating rather high wear rates, 6S40ME-B



Fig. 23: 6S46MC-C unit with POP ring pack

Cylinder Condition Update – Large Bore S-type Engines

The present market trend for many ship types is to reduce the full-load propeller revolutions using engines with a super-long stroke. For large container vessels, and within a rather short time, this trend has meant that orders for 8,000-13,000 teu vessels, where the traditional choice of engine used to be K98, are now specified with the super-long stroke S90 Mk 8 or 9 engines. Furthermore, nearly all large bore engines are now ordered as electronically controlled ME/ME-C versions.

Traditionally, the S90 engine type has been very successful as prime mover for VLCCs. The cylinder condition for this engine type has been very stable, with long times between piston overhauls at very low cylinder oil feed rates. Now, this engine type has entered service as prime mover for large container vessels with a rather different load profile and many more harbour visits. Therefore, we are following early cylinder condition feedbacks in this relation. A scavenge port inspection after a little more than 1,800 hours showed excellent condition, see Fig. 24.

We will of course follow up on these inspections on both the S90 Mk 8 and S90 Mk 9.

Lately, we have been faced with a new challenge arising from the large variation in scavenge air pressure, which is possible on the modern ME engines equipped with a waste heat recovery (WHR) system, exhaust gas bypass (EGB) and auto-tuning.

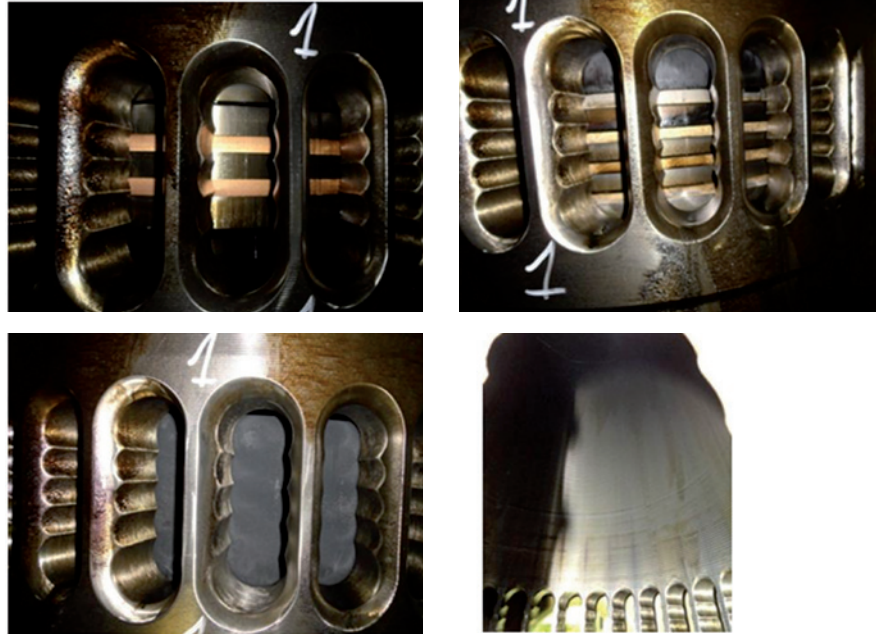

Fig. 24: S90ME-C8 in container vessel application. Scavenge port inspection after 1,800 hours revealed excellent condition

On the first series of the S80ME-C Mk 9 type engine, we have experienced initial cylinder condition problems due to the large variation in scavenge air pressure in the whole load range of the engine.

An example from one of the first S80ME-C Mk 9 engines is described in the following.

In the first period of operation, the engine was operated with a rather high scavenge air pressure between 1.1 bar to 2.4 bar in the load range from 40% to 70%. Fig. 25 shows the CoCoS EDS data logged during this time period. The reason for the high scavenge air pressure was low usage of WHR and closed EGB.

In this period, the cylinder liners suffered from cold corrosion due to the rather low liner temperature and excessive acid condensation on the liner sur-

face, see Fig. 26. The countermeasure chosen to deal with this problem was a re-design of the cylinder liner to achieve a higher liner surface temperature combined with an increase in the jacket cooling outlet temperature.

In a later period (4th quarter of 2011), CoCoS EDS data showed much lower scavenge air pressures, between 0.6 bar to 1.5 bar in the load range from 40% to 70%, see Fig. 27.

In the later period, the engine suffered from collapsed and broken piston rings, see Fig. 28. The reason for this was a high usage of WHR, rather low compression pressure and still maximum pressure according to the model curves. This resulted in a very high pressure rise and high load on the piston ring pack, especially the top piston rings.

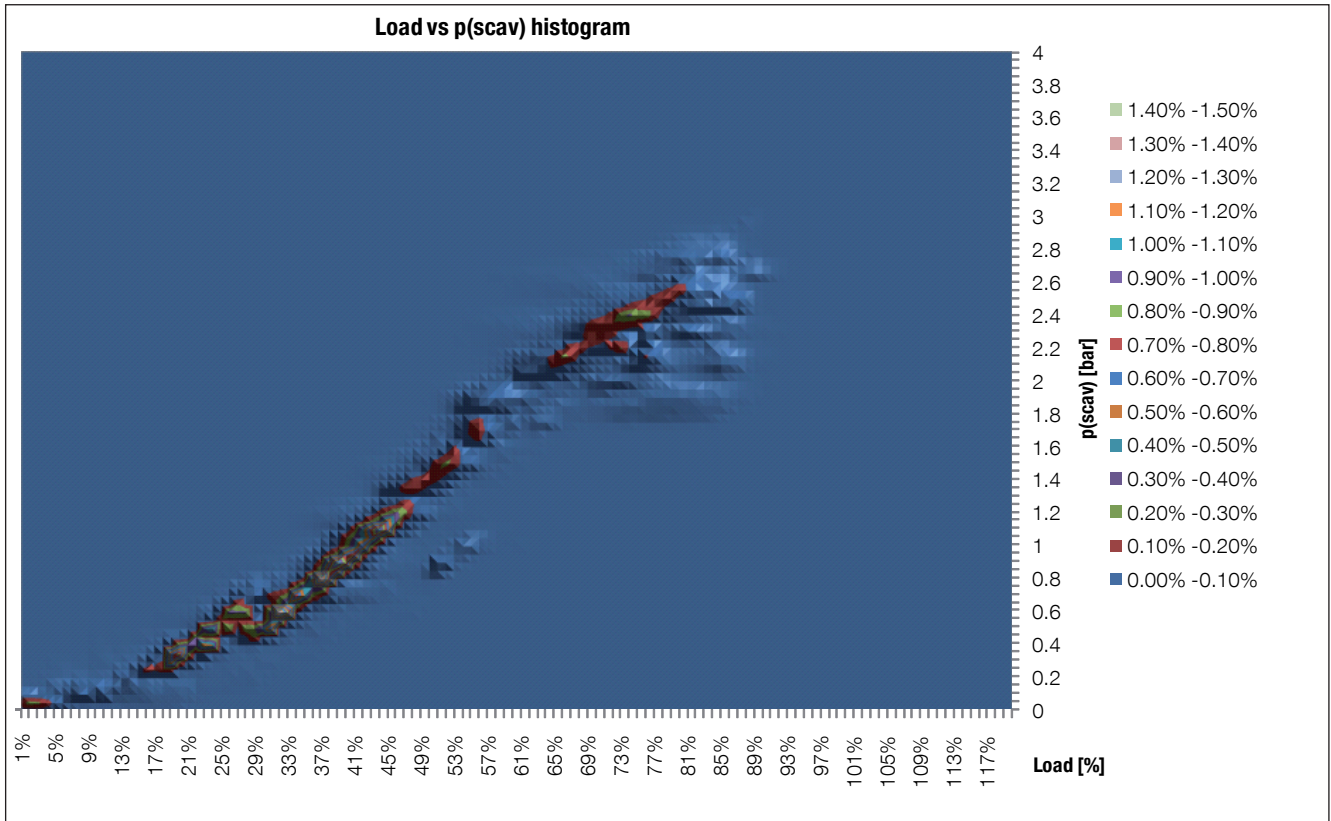

Fig. 25: CoCoS-EDS data, scavange air pressure in one period on S80ME-C9

To avoid this, improved control via the ME-ESC system is necessary to protect the engine against this situation and stabilise the cylinder condition.

Tests in this respect are currently in progress. Initial results, see Fig. 29, indicate that our countermeasures work well.



Fig. 26: Cold corrosion in the top of the cylinder liner

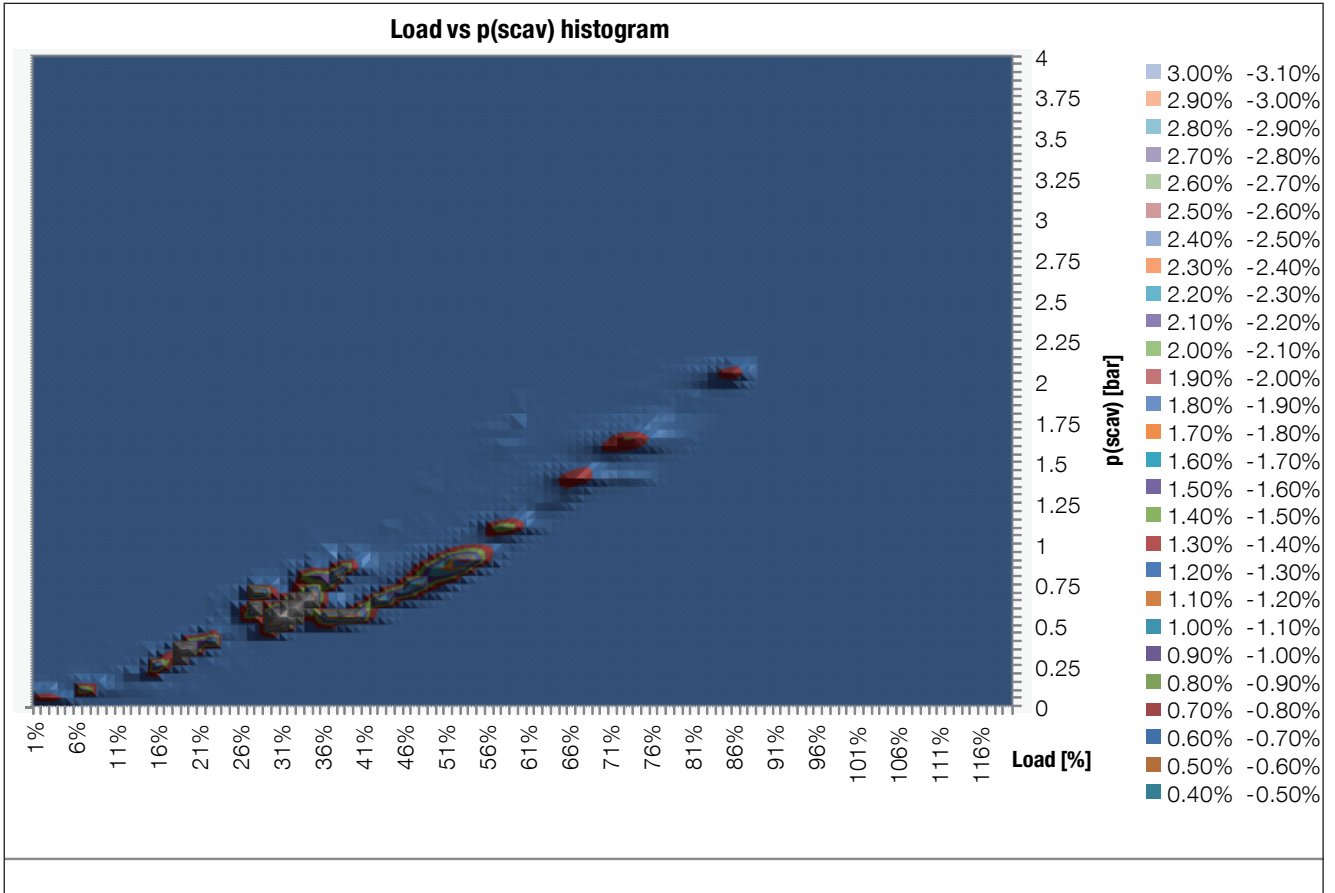

Fig. 27: CoCoS-EDS data, scavenge air pressure in another period



Fig. 28: S80ME-C9: Collapsed/broken piston rings

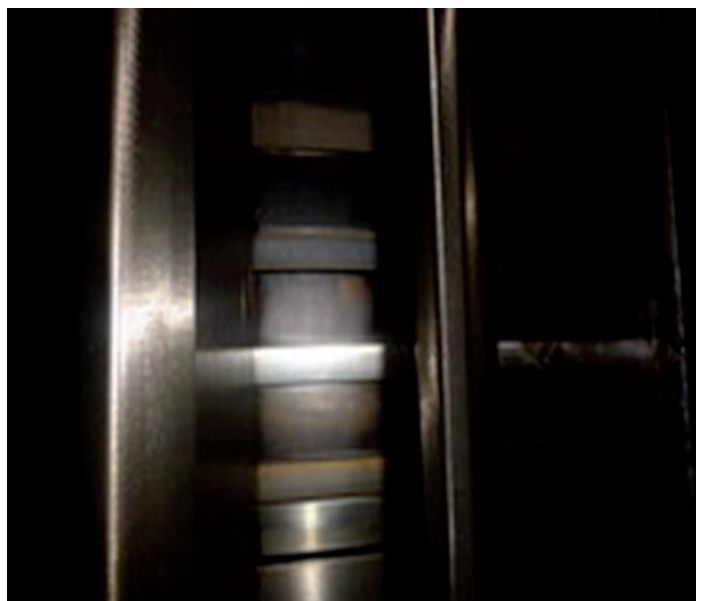

Fig. 29: S80ME-C9: Good cylinder condition

Case Story: Jumping Fuel Injectors on S50ME-C with 300-bar Hydraulic System

At the end of 2011, we received a number of reports of fuel injector malfunction on the first S50ME-C engines with the 300-bar hydraulic system. The incidents occurred after less than 1,000 hours of operation and, in a few cases, the jumping fuel injectors led to broken fuel valve studs and gas leakage between the fuel injector and cylinder cover. The damaged parts, i.e. broken studs, carbon deposits in the cut-off shaft, damaged valve seat and gas blow-by, are shown in Fig. 30.

The sequence of events can be summarised as follows:

- Fuel oil pressure disappears too fast from the fuel injector (before the cut-off shaft can close) →
- Combustion gas enters fuel valve →
- Closing speed of cut-off shaft increases →
- Hard impact between cut-off shaft and spindle guide →
- Plastic deformation of seat between fuel valve and cylinder cover →
- Correct pre-tension of fuel valve studs is lost →
- Cylinder gas acts on the O-ring diameter of fuel valve →
- Valve starts jumping and, in some cases, the valve stud breaks.

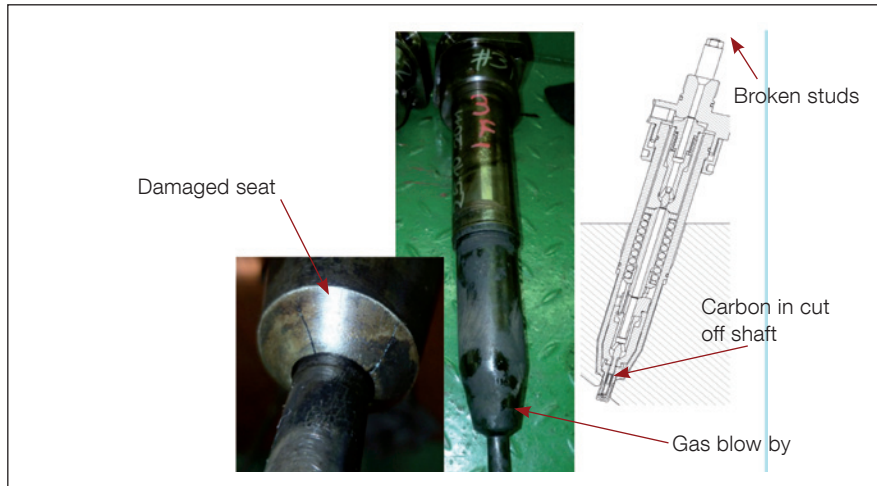

Fig. 30: Damaged parts of fuel valve

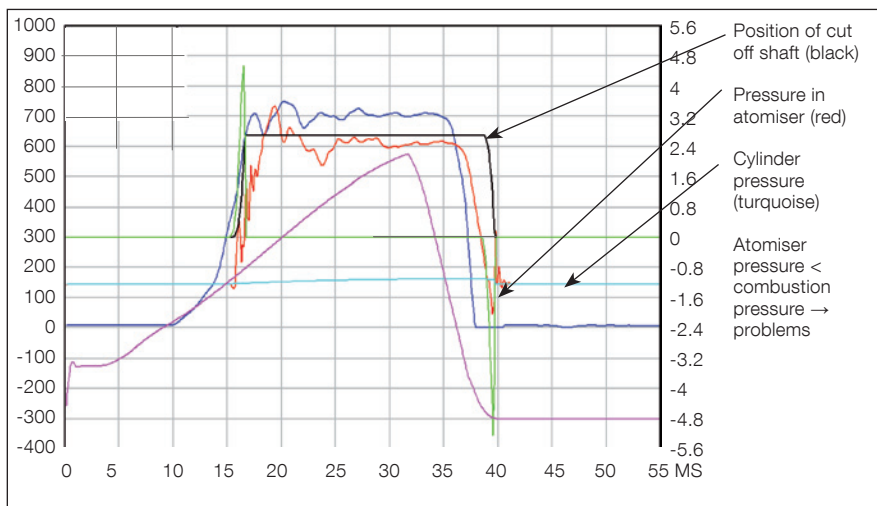

Fig. 31: Initial closing parameters

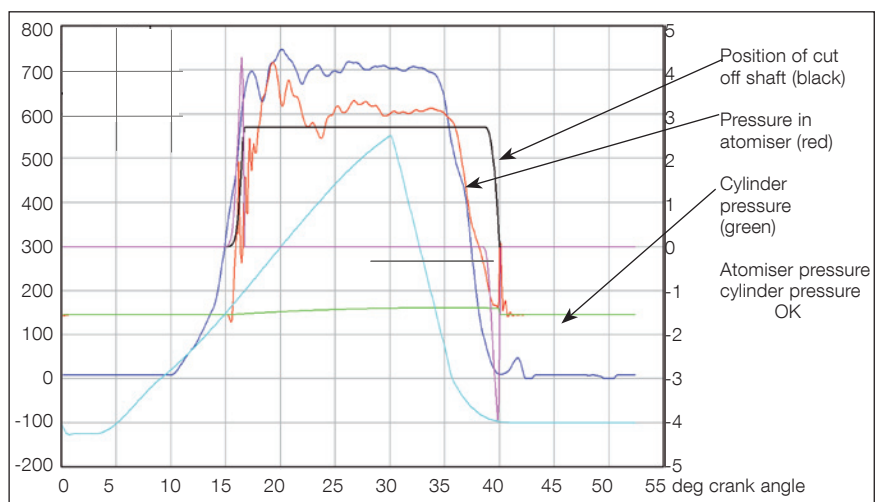

Fig. 32: Softer closing parameters

This sequence of events is supported by pressure measurements in the fuel valve itself. The initial closing parameters for the fuel valve pressure, see Fig. 31, drop faster than the cylinder pressure, thereby, enabling combustion gases to enter the fuel valve.

The solution is to apply softer closing parameters for the fuel valve (fuel booster). This can be done by a parameter change in the ME-ECS. Fig. 32 shows pressure measurements with softer closing parameters. The cylinder pressure is below the pressure in the fuel valve at all the times.

Tests in service with the new softer parameters have confirmed that this is the solution to the issues experienced. Therefore, we have performed calculations and tests on all ME engines with 300-bar hydraulic pressure to verify that this issue has been solved.

Case Story: Breakage of High-pressure Fuel Pipes on 6S80ME-C Mk 9

The S80ME-C9 high-pressure fuel pipe design comprises one hose-type pipe from the fuel booster to a distributor block and short double-bended fuel pipes from the distributor block to the three fuel valves. Fig. 33 gives an outline of the design.

We have experienced some cases of cracks in the central hose-type high-pressure fuel pipe from the fuel booster to the distributor block, see Fig. 34. An

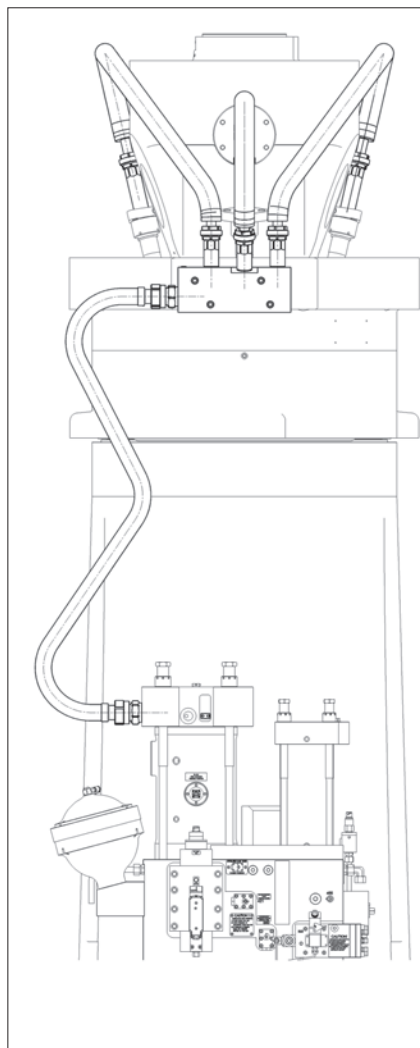

Fig. 33: High-pressure fuel pipe design on S80ME-C9

inspection of the parts on pipes with cracks revealed seizures on both the pipe union and on the bore in the distributor block, see Fig. 35.

When creating the seizures, a torque is required and this torque will reduce the clamping force and risk of fretting and wear, and thereby the risk of crack formation is increased.

The original design of the high-pressure pipe from booster to distributor block includes “uneven” angles and, furthermore, it is rather stiff and requires very precise manufacturing and assembling to avoid the above-mentioned seizures.

Therefore, we have re-designed this high-pressure pipe introducing a more flexible pipe with parallel pipe ends. Fig. 36 shows the original pipe design and the new so-called sigma-pipe. The sigma-pipe will be introduced on all S80ME-C9 engines including those already in service.

On the S80ME-C9 engine type, we have also introduced softer closing parameters and design changes to reduce the shock load on the high-pressure pipe as well as on the fuel injectors.



Fig. 34: Cracked central high-pressure fuel pipe of the hose type

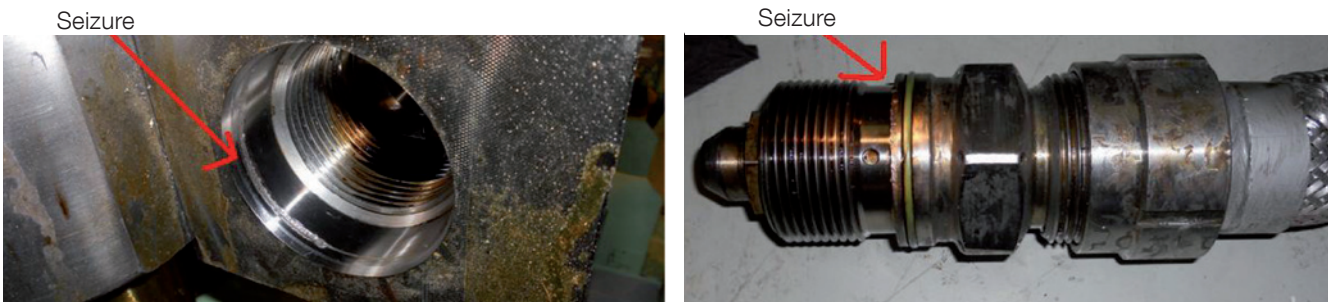

Fig. 35: Seizures on distributor block and pipe union

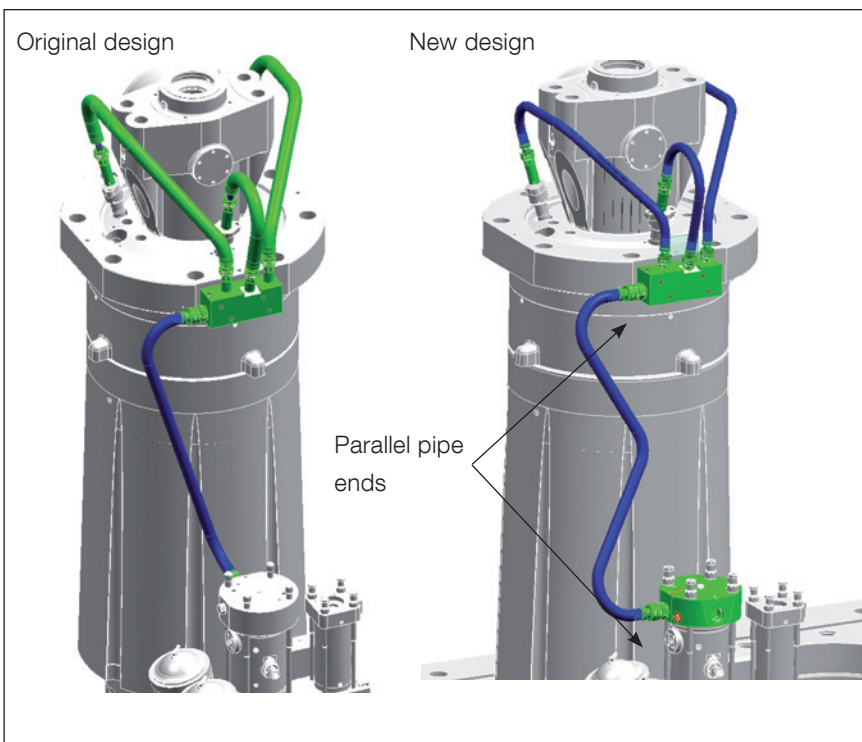

Fig. 36: Original and new pipe designs

Design – Production – In-service Cycle for MAN B&W Two-stroke Engines

The above two case stories, one for fuel injection parameters and one for high-pressure fuel pipes, illustrate the rapid response to feedback from service that our two-stroke organisation must be able to produce in order to be successful.

Fig. 37 illustrates the cycles that all new designs/engines go through. In principle, new technologies/designs are constantly being prepared in our R&D departments. When the new technologies/designs have been sufficiently

matured by advanced calculations and tests (including often service tests), they are entered in specific new designs in the existing engine programme or on newly introduced engines. This is done by the design offices in the Engineering department. The detailed design work on a new engine is typically initiated by an order for this engine. Feedback during the detailed design work phase is given from the design offices to the R&D departments.

In the next phase, the licensee produces the engine based on the design specification delivered. In this phase, the Production Support department

follows up on production related issues and feeds back information for production optimisation, etc., to both the R&D and Design departments.

When the commissioning phase starts, with shop test of the engine, the Operation department assists, and feedback from the commissioning phase (shop test, quay trial and sea trial) is given to the R&D and Design departments. This feedback typically continues throughout the guarantee period, and often also somewhat longer depending on the agreements with the shipowner in question.

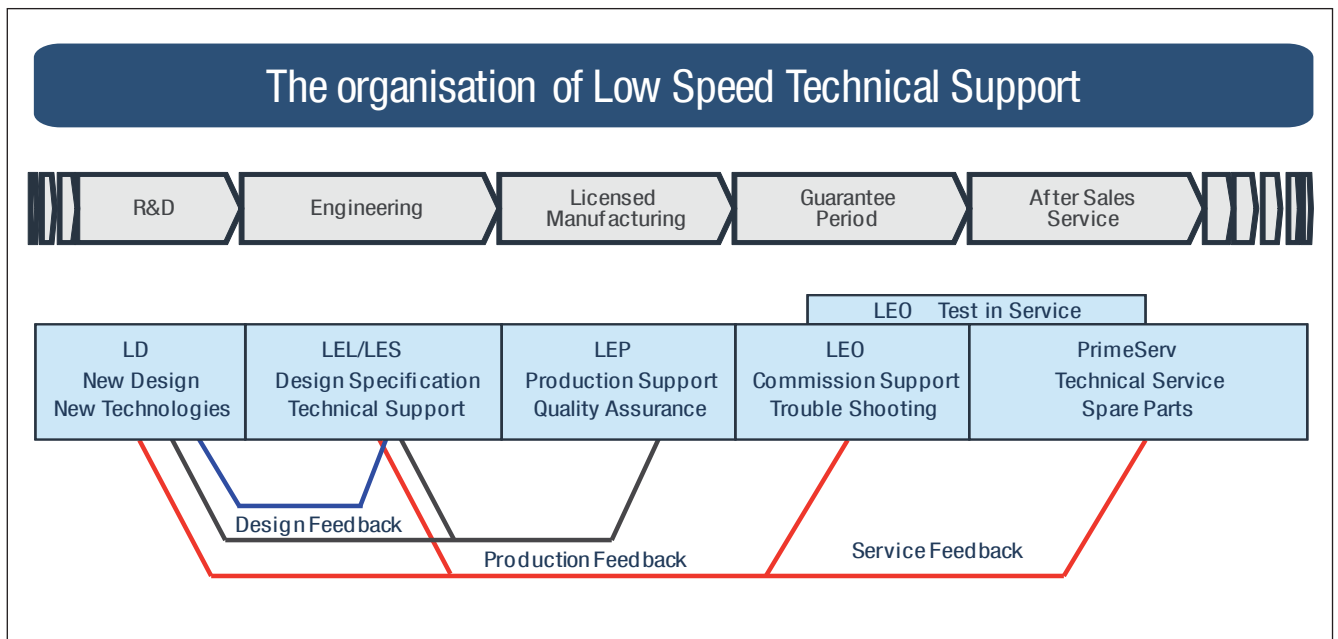

Fig. 37: MAN B&W two-stroke feedback cycle

Fig. 38 shows the development of a number of vessels powered by MAN B&W two-stroke engines in the age group from 0 to 3 years. A strongly increasing population can be seen during the last years, and we can look forward to a further increase in the years to come. This gives us an outstanding possibility of receiving efficient feedback and further optimise the MAN B&W two-stroke concept.

After the guarantee period, our service organisation, PrimeServ, takes over and continues feeding back information throughout the lifetime of the vessel/engine.

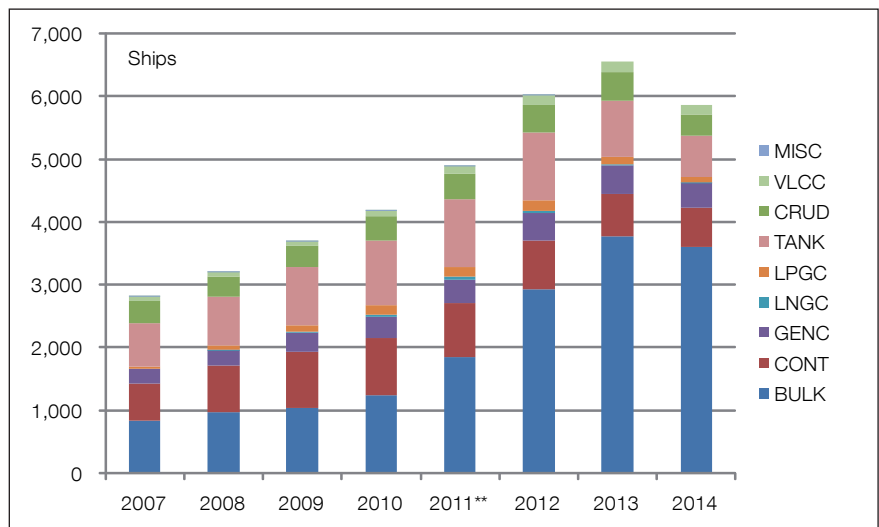
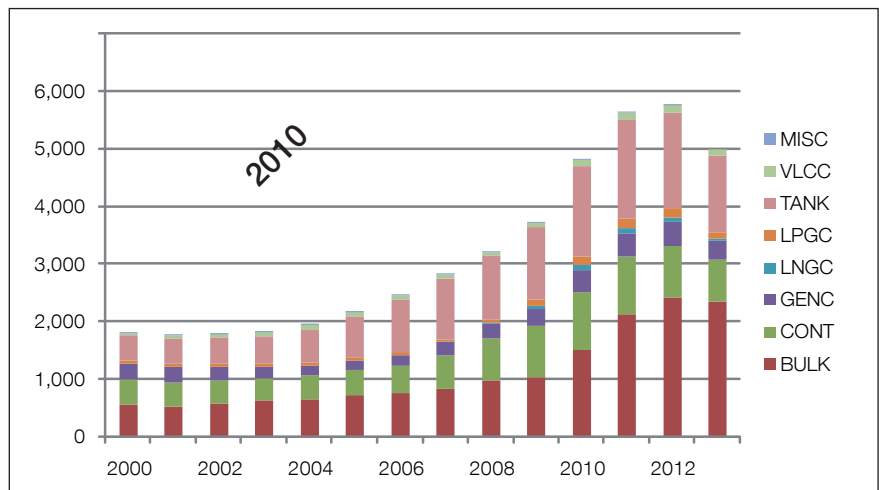
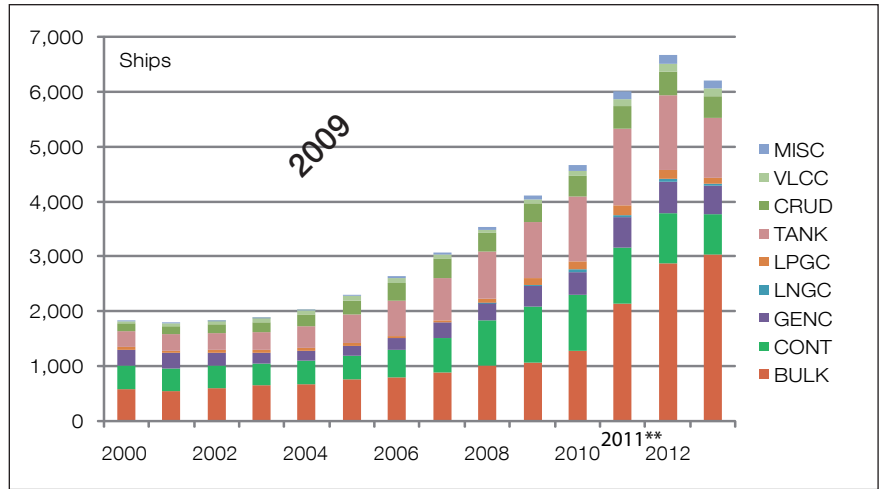

Fig. 38: Number of ships powered by MAN B&W two-stroke engines in the age group 0 to 3 years

Conclusion

A service experience update has been given. Today, electronically controlled versions of MAN B&W two-stroke engines, the ME engines, now account for the major part of new engines ordered. This paper has demonstrated that this coincides with the fact that the reliability of both electronic and hydraulic components has improved significantly.

However, it is still important to note that the classic topics for two-stroke engines, such as cylinder condition, bearing performance, fuel equipment reliability, etc. still call for attention so as to safeguard the continued success of the MAN B&W two-stroke brand.

The worldwide situation in shipping continues to put focus on extreme low-load operation. We can still say that experience with low-load operation on MAN B&W two-stroke engines is nearly 100% positive.

In the future, we will continue to concentrate on maintaining a high reliability with the up-coming focus on EEDI and, not least, Tier III technology.

All data provided in this document is non-binding. This data serves informational purposes only and is especially not guaranteed in any way. Depending on the subsequent specific individual projects, the relevant data may be subject to changes and will be assessed and determined individually for each project. This will depend on the particular characteristics of each individual project, especially specific site and operational conditions. Copyright © MAN Diesel & Turbo. 5510-0116-00ppr Jun 2012 Printed in Denmark

MAN Diesel & Turbo

Teglholmegade 41
2450 Copenhagen SV, Denmark
Phone +45 33 85 11 00
Fax +45 33 85 10 30
info-cph@mandieselturbo.com
www.mandieselturbo.com