

MAN B&W Diesel



USER'S GUIDE



**Off-line PMI System
Pressure Analyser**

1142958 - 4



User's Guide

PMI System (Off-line)

Pressure Analyser

Version 2.3

About this Guide

This User's Guide applies to MAN B&W Diesel's Off-line PMI System. It provides an introduction to and an overview of the entire PMI System for off-line cylinder pressure measurements on MAN B&W Diesel engines on board ship and at stationary power plants.

The guide sets out to provide engine staff with the knowledge essential for understanding the principle of operation and function of the PMI System, so that they can more quickly begin using it for measurements.

Before starting to use the PMI System, it is essential that it is correctly installed by qualified service personnel. Full instructions for doing this are available in the separate Mounting and Installation Guides which are provided with the system.

Copyright © 1999 – 2005, MAN B&W Diesel A/S

All rights reserved. No part of this publication may be reproduced or distributed in any form or by any means, without prior consent in writing from MAN B&W Diesel A/S.

Conditions of Licence

The supply, distribution and use of the PMI System and Data media, including System Documentation, are subject to your acceptance of the Standard Conditions of Licence which are supplied in the Software Package containing the PMI System.

Taking the PMI System in use will indicate your acceptance of these conditions.

Trademarks

Windows is a trademark of the Microsoft Corporation, U.S.A.

Table of Contents

1. Before You Begin

1.1 About this User's Guide	1 - 2
1.2 PMI System's 'On-line Help'	1 - 3
1.3 Conventions	1 - 4

2. Getting to Know the PMI System

2.1 What is the PMI System?	2 - 2
2.2 The Basic System	2 - 2
2.3 Main Features	2 - 6
Pressure Measurement Views	2 - 6
Calculated Values	2 - 8
Determination of TDC	2 - 8
Crankshaft Torsion Correction	2 - 8
Cylinder Identification	2 - 9
2.4 Supplementary Features	2 - 9
Standard PC Hardware	2 - 9
Windows Display & Operation	2 - 10
On-line Help	2 - 10
Data Backup	2 - 11
Use with Other Software	2 - 11

3. Exploring the PMI System

3.1 Starting the PMI System	3 - 2
3.2 The PMI Windows Environment	3 - 2
Main Window	3 - 2
Mouse/keyboard Operation	3 - 4
3.3 Opening Engines	3 - 5
3.4 Opening Measurements	3 - 6
3.5 PT Diagrams	3 - 8
3.6 PV Diagrams	3 - 11
3.7 Balance Plots	3 - 12
3.8 Calculated Values	3 - 14

4. Pressure Measurements

4.1 Making Pressure Measurements	4 - 2
4.2 Checking & Editing Measurements	4 - 4
4.3 Deleting Measurements	4 - 8
4.4 Backing Up & Restoring the PMI Database	4 - 9

5. PMI Menus & Commands

5.1 File Menu	5 - 2
5.2 View Menu	5 - 2
5.3 Tools Menu	5 - 3
5.4 On-line Help	5 - 4
Help Menu	5 - 4
Function Key F1	5 - 5

Appendix

A.1	Technical Specification	A - 2
	Off-line PMI System	A - 2
	Computer Requirements	A - 3
A.2	Software Installation	A - 3
A.3	Care & Handling of Equipment	A - 4
A.4	System Checks	A - 6
	Communication Options	A - 6
	Engine Address	A - 7
	Trigger Test	A - 8
A.5	Maintenance Checks & Adjustments	A - 11
	Angle Encoder	A - 11
	LE-Pickup	A - 13
	PD-Pickup	A - 15
A.6	Troubleshooting	A - 16
A.7	Technical Assistance	A - 22

Glossary

Glossary of Terms	G - 1
-------------------------	-------

Index

Before You Begin

Welcome to MAN B&W Diesel's Off-line PMI System for cylinder pressure measurements and analysis on diesel engines.

The PMI System is designed to provide engineers and service staff on board ship and at power plants with a computerised tool for cylinder pressure measurements on MAN B&W two and four stroke diesel engines.

It consists of a pressure transducer, a PMI Controller and a trigger system with crankshaft pickup which can be operated using an IBM compatible PC on which the PMI System software is installed. The system is supplied with the necessary hardware and software, and is designed to automatically calculate, display and log measurement results. Primary features include:

- Graphic presentation of PT, PV and Balance Diagrams, together with Mean Indicated Pressure and Maximum Pressure deviation limits
- Calculated values of Effective Power, Mean Indicated Pressure p_i , Compression Pressure p_{comp} , Maximum Pressure p_{max} and Scavenge Pressure p_{scav} , including proposed values for Index Adjustments, etc.
- Print out of results.
- Software interface for use with MAN B&W Diesel's engine performance and engine diagnostics software, e.g. CAPA Performance and CoCoS-EDS

In this Chapter

- [About this User's Guide](#) 1 - 2
- [Conventions](#) 1 - 4
- [PMI System's 'On-line Help'](#) 1 - 3

1.1 About this User's Guide

This User's Guide is prepared to give the knowledge essential to understanding the concept, structure and function of the PMI System.

The guide is structured to provide both brief and detailed information in order that you can quickly and easily obtain an overview of the PMI System, as well as become familiar with the majority of its commands.

The guide includes the following chapters:

Chapter 1 – Before You Begin: This is the chapter which you are now reading. It provides a brief introduction to the PMI System and the contents of this User's Guide, and includes details about text conventions.

Chapter 2 – Getting to Know the PMI System: This provides a short, but detailed account about the PMI System so that you can quickly gain an overview of its main applications and features.

Chapter 3 – Exploring the PMI System: This deals with basic operation of the PMI System. It explains what you need to know in order to start using the program for viewing measurements.

Chapter 4 – Pressure Measurements: This chapter concerns making pressure measurements with the PMI System, editing them and creating backups of your database.

Chapter 5 – The System Menus & Commands: This provides a simplified overview of the commands available with the menu system of the PMI System.

Appendix – This gives brief information on the system requirements for using the PMI System on your computer and advice on troubleshooting.

Glossary – This explains many of the terms and abbreviations used throughout this guide

For detailed information and instructions concerning installation and set-up of the PMI System, please consult the separate Mounting and Installation Guides which are provided with the system.

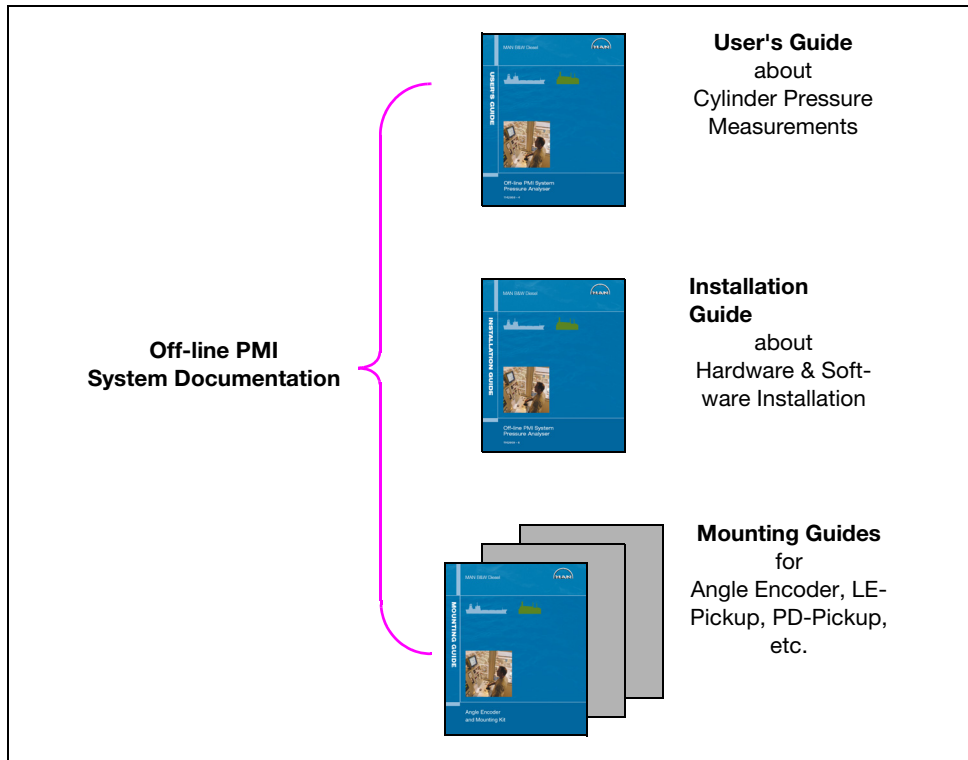

Fig. 1-1. System documentation available for the Off-line PMI System

1.2 PMI System's 'On-line Help'

To help you in hands on use of the PMI System, its application software includes on-line help information. This is available directly on your PC whenever using it together with the PMI System. It is activated by pressing the function key 'F1' on the keyboard and explains about each of the com-

mands and functions that are available for making measurements, displaying, editing and deleting measurement results.

1.3 Conventions

Illustrations:

The illustrations shown in this guide are examples only and although typical of what you can expect to see when using the PMI system, depend on the particular engine plant and crankshaft pickup employed.

Settings & Values:

The values and settings shown in the displays and stated in accompanying text throughout the guide, are included as examples only.

Menus & Menu Commands:

References to specific commands that are given in menus and dialogue boxes are indicated in single quotes, e.g. 'Open Engine' in the 'File' menu.

Commands depicted with a leader, i.e. 'Options ...', open a selection dialogue which offer a number of options to choose from, while those without a leader, i.e. 'Print', immediately initiate the particular action designated.

Suffixes to measurement parameters are given in parentheses in the PMI application and in subscript in the User Guide. e.g. $p(\text{scav}) = p_{\text{scav}}$

For details on the conventions used for indicating mouse and keyboard functions with a PC, see [section 3.2.2](#).

Getting to Know the PMI System

This Chapter provides a short account about the PMI System. It describes its main applications and features so that you can obtain an insight into how it can help you with your day-to-day work on your diesel engine plant.

In this Chapter

- **What is the PMI System?** 2-2
- **The Basic System** 2-2
- **Main Features** 2-6
 - Pressure Measurement Views 2-6
 - Calculated Values 2-8
 - Determination of TDC 2-8
 - Crankshaft Torsion Correction 2-8
- Cylinder Identification 2-9
- **Supplementary Features** 2-9
 - Standard PC Hardware 2-9
 - Windows Display & Operation 2-10
 - On-line Help 2-10
 - Data Backup 2-11
 - Use with Other Software 2-11

2.1 What is the PMI System?

The **PMI System** is designed to provide engineers and service personnel onboard ship and at power plants with a portable computerised tool for cylinder pressure measurements on MAN B&W two-stroke and four-stroke diesel engines.

The main advantages of the PMI System are:

- Easy to use and needs only one person to operate.
- Sensitive yet robust Pressure Transducer and PMI Controller Unit.
- Versatile trigger system. Operates with a variety of different pickups (angle encoder, light emitting and proximity pickups available) for detecting the crankshaft angle/rotation. It generates a large number of crankshaft angle/position pulses for optimum accuracy. No frequency multiplication is involved.
- Quick, reliable results. A complete set of measurement results takes less than 10 minutes to produce.
- Excellent accuracy compared to traditional indicating devices, including other computerised systems for measurements on diesel engines.
- Uses a standard IBM compatible PC – yet requires no detailed knowledge of computers.

In addition, it has been field tested by MAN B&W Diesel's own service engineers and incorporates MAN B&W Diesel's accumulated know-how and expertise regarding diesel engine design, performance testing and measurements.

2.2 The Basic System

A schematic of the PMI System is shown in [Fig. 2-1](#).

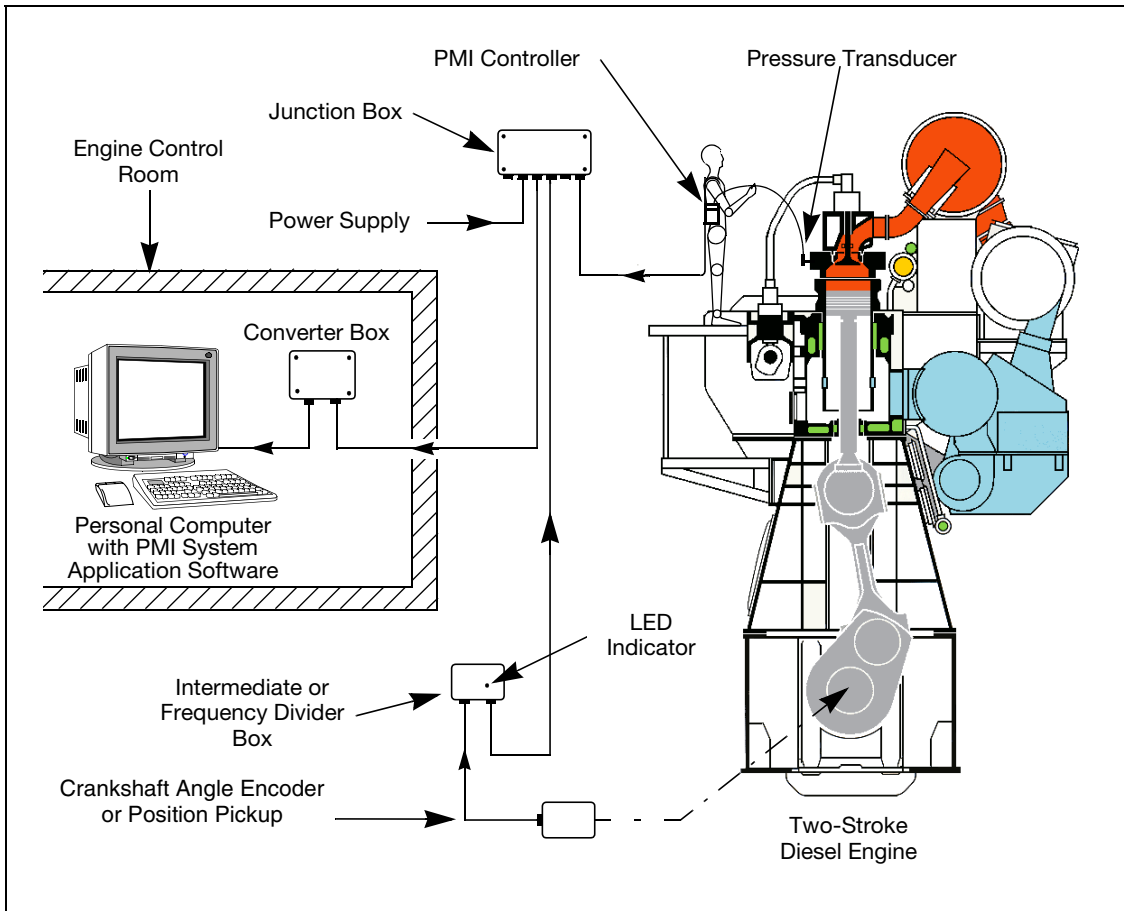

Fig. 2-1 Schematic of the Off-line PMI System (not to scale)

The off-line version of the system employs a high-performance piezo-electric transducer of well proven design which is mounted on the cylinder head indicator cock from which the cylinder pressure is measured. The transducer is manually moved from one cylinder to another between each set of measurements, and therefore is only exposed to the harsh environment of the combustion chamber for a very short period of time. This principle results in very reliable and stable measurements.

To obtain a pressure indication which accurately describes the change in cylinder pressure throughout each work cycle of an engine, the pressure detected by the transducer must be synchronised with the motion of the engine. For this purpose, the PMI System is especially designed to be used with different types of crankshaft pickup, for example:

- **Angle Encoder:** A sealed unit which is fastened to engine crankshaft via a flexible coupling. It contains an externally driven, optically encoded disc, mounted between an internal light source and detector.
- **LE- Pickup:** A pair of light emitting sensors which detect the light reflected from a continuous strip of zebra tape bonded on the drive shaft of the engine.
- **PD-Pickup:** A pair of proximity detectors which are based on inductive pickups. They detect the rotation of a TDC marker and the individual teeth of a gear wheel or specially designed trigger ring at the aft of the crankshaft.

All types of pickup produce a train of electrical pulses which are used to detect the absolute position of the crankshaft. In addition, they produce a separate pulse which is used to synchronise the PMI System with the TDC position of Cylinder No. 1.

Pickup	Engine Type & Layout	Mounting	Maintenance
Angle Encoder	Main & Aux. Engines without PTO	Engine Crankshaft via flexible coupling	Sealed unit requiring little or no maintenance
LE-Pickup & Zebra Tape	Main & Aux. Engines with or without PTO	Zebra tape bonded on free section of engine drive shaft	Zebra tape must occasionally be cleaned
PD-Pickup	Main & Aux. Engines with or without PTO	Operates from gear wheel or specially designed trigger ring on engine	Immune to most disturbances

Table 2-1 Crankshaft Pickups for use with the PMI System

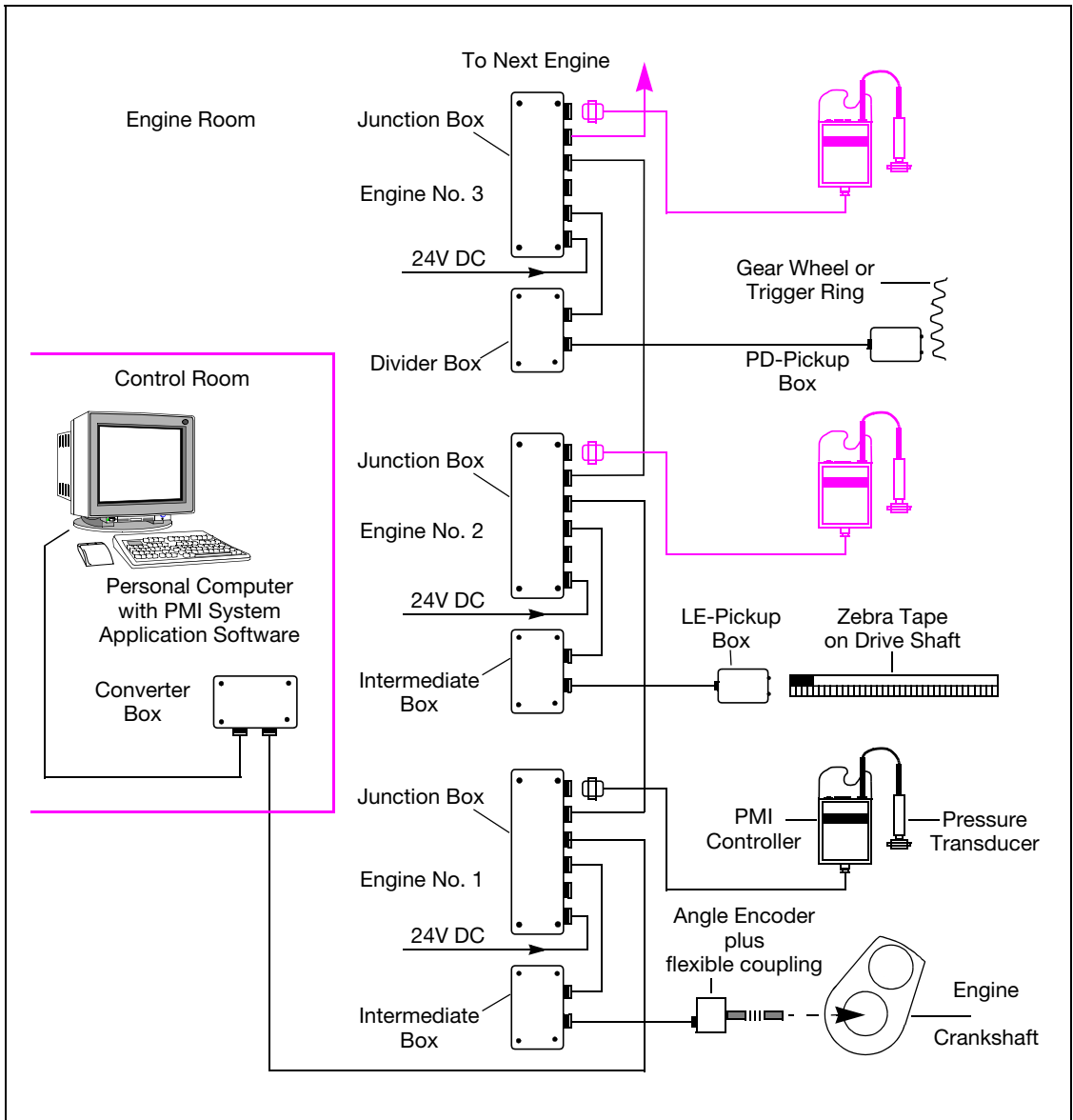

Fig. 2-2 Connection of PMI System with an Angle Encoder, Light-emitting and/or Proximity Pickups

As indicated in [Table 2-1](#) the choice of appropriate crankshaft pickup and its connection with the PMI System (see [Fig. 2-2](#)), depends on the engine layout.

With the Angle Encoder a precise number of crankshaft angle/position pulses are generated (e.g. 1024) per revolution of the crankshaft, while with the other sensors the number of pulses depends on the diameter of the drive shaft or the number of teeth on the gear wheel or trigger ring on the engine.

The crankshaft pickup pulses from the engine are first fed to either an Intermediate Box or Frequency Divider and then on to a Junction Box. From there they are relayed to the portable PMI Controller which is attached to the pressure transducer and serves as the system's remote nerve centre for controlling measurements.

All of the equipment is powered by an external 24 V DC source and except for the pressure transducer and portable PMI Controller, are mounted as a permanent fixture in situ with the engine. Both the PMI Controller and the Junction Box include the appropriate communication interfaces necessary to collect the data and automatically transfer it to a PC. For subsequent calculation, display and storage of the data using the PC, the software supplied with the PMI System must be installed.

2.3 Main Features

2.3.1 Pressure Measurement Views

The cylinder pressure measurements that are collected and stored in the database of the PMI System can be viewed on the PC using three different graphic presentation modes. These include PT Diagrams such as that shown in [Fig. 2-3](#), as well as PV Diagrams and Balance Plots.

In the particular case of the PT diagram (see [Fig. 2-3](#)), each curve is shown over a full work cycle of the engine, i.e. pressure [bar] versus crankshaft

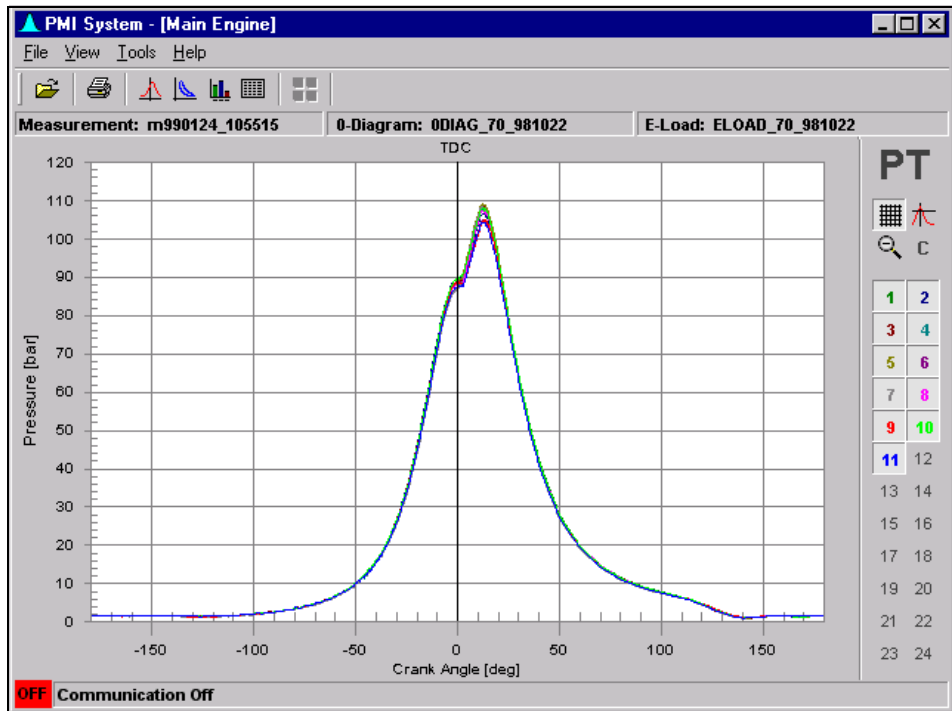

Fig. 2-3 A PT Diagram

angle [degrees], but is plotted relative to a common TDC so as to allow easy comparison with the other curves that are shown.

With PV Diagrams, cylinder pressure is shown against the relative volume [%] of the cylinder, while with Balance Plots the Compression Pressure p_{comp} , Maximum Pressure p_{max} and Mean Indicated Pressure p_i of all the cylinders are shown.

The PT and PV diagrams also include a tool panel. This enables you to switch 'On' and 'Off' the display grid, display cursor and the individual curves shown for each of the cylinders, simply by clicking on the corresponding buttons with the mouse.

Similarly, by dragging the mouse over any portion of the pressure curves you can zoom in and obtain a magnified view of the area selected.

2.3.2 Calculated Values

Besides alternative graphic views for viewing measurements, information can also be obtained in tabular form. With both two and four stroke engines values for the Compression Pressure p_{comp} , Maximum Pressure p_{max} , Scavenge Air Pressure p_{scav} and Engine Speed are given. In addition, the Mean Indicated Pressure p_i and Effective Power, are given with two stroke engines.

Also stated for two-stroke engines, are calculated values for 'VIT', 'Shim' and 'ME' fuel pump adjustments. These indicate how much the index of each of the cylinders must be adjusted to get the engine properly balanced. Depending on the type of fuel pump the results are expressed as a change in “index”, “rotation of link”, “Shims to be added/removed” or as plain pressure adjustment values.

2.3.3 Determination of TDC

The PMI System is designed to determine the TDC of the cylinders from a set of '0-Diagram' reference measurements. These measurements are usually made only once on a given engine when the PMI System is first installed.

'0-Diagram' measurements are made by first letting the engine run at about 50 to 75% load and then shutting off the fuel oil to the cylinder to be measured by setting its fuel pump index to zero or by disengaging the pump by lifting the roller gear. When the engine has stabilised, the pressure transducer is connected to the indicator cock of the cylinder and a measurement taken. See Installation Guide for further details.

2.3.4 Crankshaft Torsion Correction

A secondary factor which can influence the TDC's of an engine is the torsional displacement or twisting experienced by each section of crankshaft due to the torque transmitted.

With the PMI System this is accounted for by taking an additional set of reference measurements at constant load. These are called 'E-Load' measurements and differ from '0-Diagram' measurements in that a normal supply of fuel oil is maintained on all cylinders throughout the measurement.

The 'E-Load' measurement is then used together with the '0-Diagram' to calculate the correct TDC's of all the cylinders. The correction is made automatically for each cylinder and is based on the torsional coefficients specified in the PMI System's software. See Installation Guide for further details.

2.3.5 Cylinder Identification

A useful feature of the PMI System is that it automatically recognises and keeps track of which cylinders measurements are made on. It is therefore able to follow the progress of a measurement and indicate the exact order that the individual cylinders are measured, even when they are measured in a random order. In addition, it is able to inform about the number of measurements made on each cylinder.

With four-stroke engines, it is necessary to start measurements with Cyl. 1, as otherwise the PMI System will not correctly recognise the order of the subsequent cylinders measured.

2.4 Supplementary Features

The Off-line PMI System has a number of additional features which are intended partly to make operation easier, and partly to ensure appropriate handling of data.

2.4.1 Standard PC Hardware

The PMI System's hardware and application software can be used on any standard IBM-compatible PC. Normally, the same computer as used for

other purposes in the engine control room can be employed, provided that it has a free communication port available.

2.4.2 Windows Display & Operation

The PMI System's display is built up on a standard Windows™ environment. Although some prior experience of using windows based computer applications is desirable, it is not strictly necessary. For the most part only rudimentary skills of using a PC are needed.

Like other Windows™ based software applications, its display includes pull-down and pop-up menus. These are used for choosing specific commands and functions by selecting them with the mouse or via the keyboard of the PC.

Also, several toolbars are included. One of these is situated just below the main menu and is for quick access to the most frequently used commands that are available with the PMI System, while the other is located alongside the measurement views that are presented and is used to select pressure curves for each of the individual cylinders of a diesel engine.

2.4.3 On-line Help

Whenever using the PMI System a comprehensive on-line help feature is always immediately at hand. If in doubt about a particular operation you can press the F1 key at the top of the PC's keyboard in order to activate context sensitive help. This will display help information on screen about the particular command you are currently using.

You can also select one of the commands listed in the 'Help' menu. This enables you to search for information on any specific topic or to obtain instructions and advice on how to use a particular command.

2.4.4 Data Backup

The PMI System features manual backup and restoration of its database which contains setup data, as well as data concerning cylinder pressure measurements.

With manual backup, backup copies are stored on the hard disk of your PC or can be transferred to standard data diskettes. These can then be used to restore the database if it becomes corrupted. In addition, backup copies can be sent to head office for keeping them up-to-date about the operating status of your diesel engine plant.

2.4.5 Use with Other Software

The PMI System can be used with a number of other software applications.

For example, measurement data can be transferred from the PMI System to the CAPA Performance System or to the CoCoS-EDS Engine Diagnostics System which are available from MAN B&W Diesel.

Exploring the PMI System

This Chapter explains about operation and use of the PMI System. It provides basic details on the main window elements and commands which are available with the PMI System and shows you how to use it to obtain a clear overview of your cylinder pressure measurements.

In this Chapter

- | | | | |
|--|-------|-------------------------------------|--------|
| • Starting the PMI System | 3 - 2 | • Opening Measurements | 3 - 6 |
| • The PMI Windows Environment | 3 - 2 | • PT Diagrams | 3 - 8 |
| Main Window | 3 - 2 | • PV Diagrams | 3 - 11 |
| Mouse/keyboard Operation | 3 - 4 | • Balance Plots | 3 - 12 |
| • Opening Engines | 3 - 5 | • Calculated Values | 3 - 14 |

3.1 Starting the PMI System

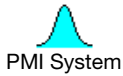

To start the PMI System use the mouse to double-click on the 'PMI System' icon contained on the windows desktop or on the corresponding program listed in the 'Start' menu on your PC.

3.2 The PMI Windows Environment

For getting acquainted with the PMI System, the following sections explain the basic elements of its main window and the use of a mouse and keyboard to operate the system.

3.2.1 Main Window

[Fig. 3-1](#) shows the main window of the PMI System. This is what you will see on the PC when you start the system. The appearance, layout and use of the main window are similar to that of other Windows™ software applications.

The main elements of the window are:

Title bar:

This bar indicates the name of the particular software application which is being run, plus the particular diesel engine that is chosen for making new cylinder pressure measurements or viewing the results of earlier measurements, i.e. PMI System – [Main Engine].

Menu bar:

This shows the names of the PMI's main menus. Clicking on the names with the left mouse button, lists the functions and commands that are available with each of these menus. Clicking on a command listed in the menu, activates the command.

Note: Only those commands which are fully visible can be activated. They depend on the particular window and the command which you last activated.

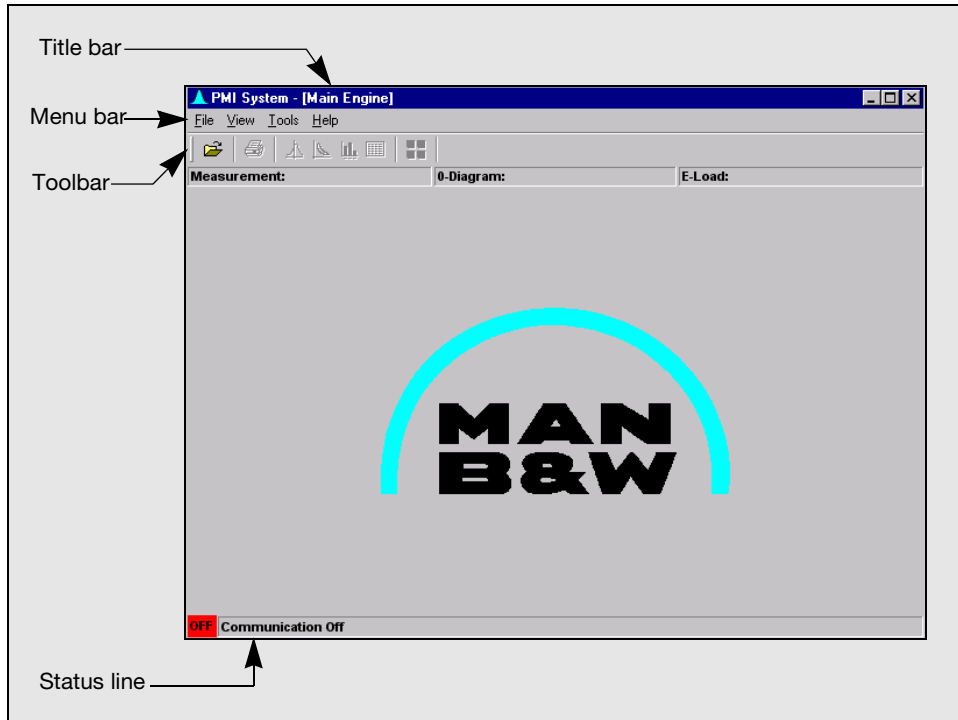

Fig. 3-1. The primary elements of the PMI System's main window

Toolbar:

This contains a row of buttons each marked with a function symbol. By using the mouse to slowly move the display cursor across the Toolbar, hints are flagged about the purpose of each button. Clicking on the buttons with the mouse provides quick access to the most frequently used commands which are also available using the Menu bar located just above the Toolbar.

As with the commands listed in the Menu bar, only those tool buttons which are fully visible can be activated. They depend on the particular window and the command or tool button which you last activated.

Status line:

A red 'OFF' or green 'ON' marker is flagged at the left-hand end of the status line. A red marker indicates that the PMI System is working off-line, i.e. is not connected with the PMI Controller, while a green marker indicates that it is checking connection and communication with the Controller.

3.2.2 Mouse/keyboard Operation

The windows, dialogue boxes and commands included with the PMI System, are chosen in the same way as with other Windows™ based applications – by using the mouse or by keyboard short cuts.

For a concise explanation this and the following sections mainly concentrate on use with the mouse, but keyboard operations are explained wherever practical.

The terms used to explain the various actions which may be performed with the mouse, are as follows:

- | | |
|---------------|---|
| Click: | Click the left mouse button |
| Right-click: | Click the right mouse button |
| Double-click: | Click the left mouse button quickly, twice in succession. |
| Drag: | Select and highlight values or text in data fields or to define part of a curve to be magnified using the 'Zoom' function. To do this, position the mouse cursor at the start of a display region of interest, press the left mouse button and while keeping the button pressed, move the cursor diagonally over the area of interest and release the button. |

The following keys emulate the function of the mouse:

Home:	Steps to the start of a list or to the start of the first character in a data field.
End:	Steps to the end of a list or to the end of the last character in a data field.
Page Down:	Steps to the bottom of a list.
Page Up:	Steps to the top of a list.
Arrow Up:	Steps up to the next adjacent line in a list.
Arrow Down:	Steps down to the next adjacent line in a list.
Arrow Left/Right:	Step left or right to the next adjacent column in a list or character position in a data field. Keeping a key pressed, scrolls to left or right in a data field.
Shift + Arrow Key:	Scroll the text cursor left or right or up or down in a data field, highlighting all characters and lines that it moves over.
Tab:	Steps text cursor to the next data field, check box or command button in a selection dialogue.
Shift + Tab:	Step to the previous data field, check box or command button in a dialogue.
Enter:	Activates a command button selected in a dialogue.
Esc.:	Cancels a command or closes a dialogue.

3.3 Opening Engines

Each time that the PMI System is opened from the Window's desktop or 'Start' menu, it automatically selects the engine that was last selected during previous use of the program. The name of the particular engine is indicated in the title bar (see [Fig. 3-1](#)) of the main window.

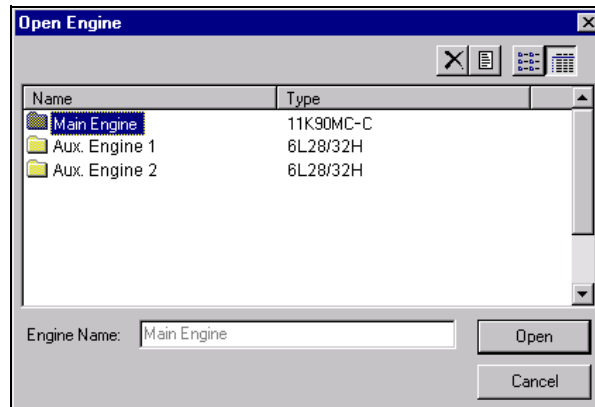

Fig. 3-2. The 'Open Engine' dialogue

With multi-engine plants, it is possible to choose other engines by selecting them with the 'Open Engine' command. This is contained in the 'File' menu and opens the dialogue shown in Fig. 3-2. To select the engine that you want to work with, left-click its name with the mouse and then click the 'Open' button. Alternatively, use the Up/Down arrow keys on the keyboard to select the name of the engine and then press the Enter key.

3.4 Opening Measurements



After selecting an engine (see previous section), you can proceed to select one of the measurements which have been stored for the particular engine. Measurements are chosen using the dialogue shown in Fig. 3-3, which is opened by activating the 'Open Measurement' command in the 'File' menu or by clicking on the corresponding button in the toolbar.



Initially measurements are listed by just their designation, but further details can be obtained by clicking the 'Details' tool button near the top, right corner of the dialogue (see Fig. 3-3).

Alternatively, 'Details' may be selected using the quick-access menu shown in Fig. 3-5, which is opened by right-clicking anywhere in the 'Open Measurement' dialogue.

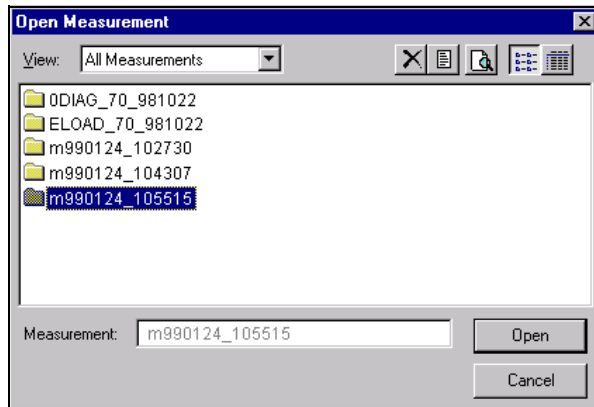

Fig. 3-3. The 'Open Measurement' dialogue

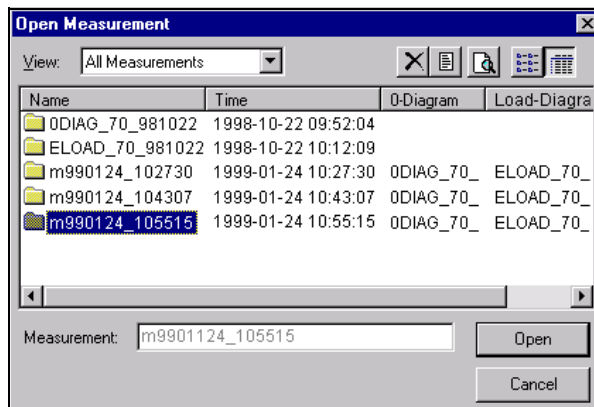

Fig. 3-4. The 'Open Measurement' dialogue as viewed with the 'Details' function

Measurements are opened by selecting them either with the mouse or with the arrow and enter keys on the keyboard. Opening a measurement, displays its pressure versus time curve, i.e. 'PT diagram' view, which is explained in the following section.

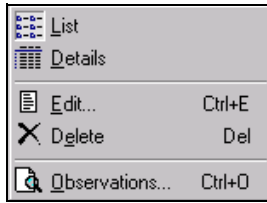

Fig. 3-5. The quick-access menu which is available by right-clicking the mouse in the 'Open Measurement' dialogue

3.5 PT Diagrams



A PT Diagram is displayed immediately on opening a measurement with the 'Open Measurement' command (see previous section). Alternatively, you can select a PT Diagram either by selecting it in the 'View' menu or by clicking on the corresponding button in the Toolbar.

A 'PT Diagram' is shown in [Fig. 3-6](#) and can contain pressure curves for up to 24 cylinders, depending on the number measured. Each curve is shown over a full work cycle of the engine, i.e. pressure [bar] versus crankshaft angle [degrees], but is plotted relative to a common TDC so as to allow easy comparison with the other curves that are shown. Also, each curve is plotted with a separate colour, in order to help distinguish between them.

As a reminder, a “No 0-Diagram Data” message is displayed whenever measurements are opened which do not include a '0-Diagram' reference measurement. See [section 4.2](#) for details about editing measurements and linking them with 'O-Diagram' measurements.

PT Tool Panel:

The PT Diagram is equipped with a Tool Panel (see [Fig. 3-7](#)). This is located on the right-hand side of the display screen and can be used to activate or de-activate various elements of the diagram. For example, you can toggle 'On' and 'Off' the display grid, display cursor and the individual curves shown for each of the cylinders, simply by clicking on the corresponding buttons.

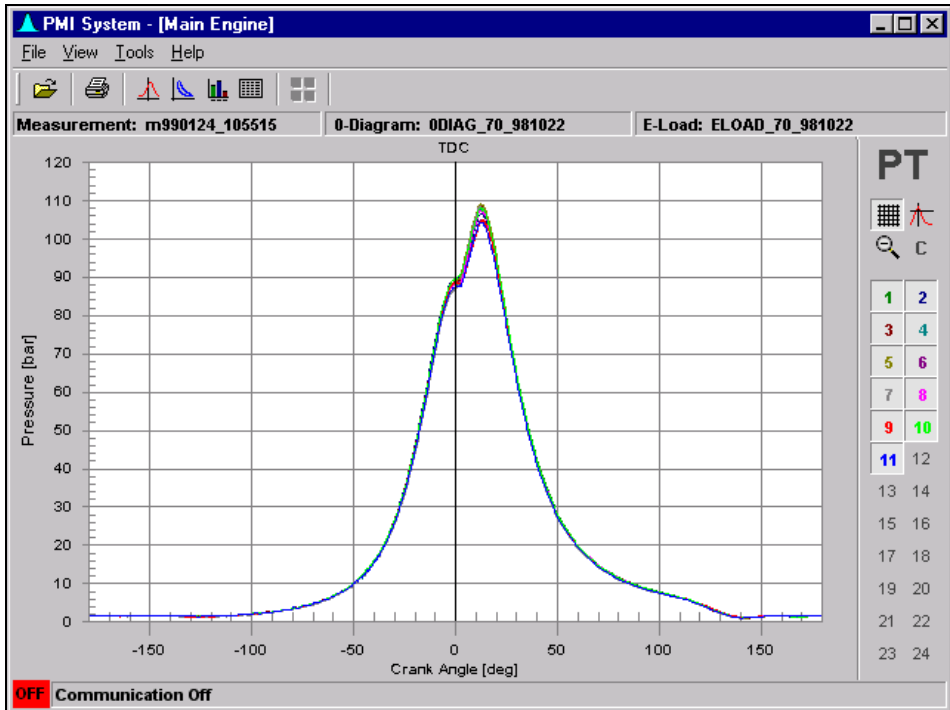

Fig. 3-6. A PT Diagram

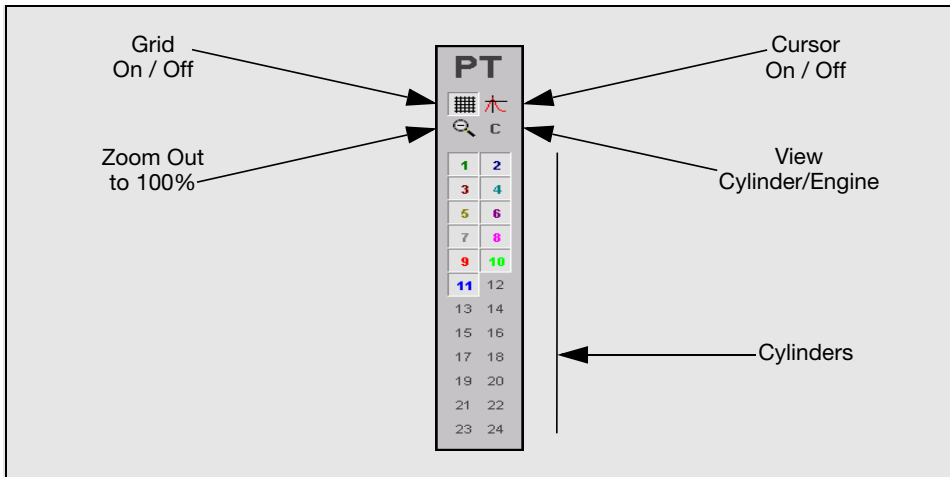

Fig. 3-7. Control Panel of the PT diagram

Also, by using the mouse to move the display cursor across these buttons, you can obtain hints about the purpose of each button.

Display Grid:



To switch on the 'Display Grid', click the button shown. The grid is active when the button is depressed.

Display Cursor:



When the 'Cursor' button is activated (i.e. button depressed), you can move the cursor up or down, or to the left or right by pressing the appropriate arrow key on the keyboard. Also you can step from one curve to the next simply by aligning the cursor on a raised portion of the curve and pressing the up or down arrow key. The selected cylinder and cursor position are indicated at the bottom of the display.

Zoom Function:

If you want to examine diagrams in more detail you can zoom in and magnify any portion of the diagrams as shown in [Fig. 3-8](#).

To zoom in on part of a diagram, position the mouse cursor at the start of the region of interest on the display. Next press the left mouse button and while keeping the button pressed, drag the cursor diagonally over the area of interest and release the button. This will magnify the area.



When you want to return to the original view, press the 'Zoom' button in the tool panel to deactivate it.

Cylinder / Engine View:



This button is only active when a measurement contains more than one observation per cylinder. Press the 'Cylinder View' button 'C' to switch to the 'Cylinder' display mode or press the 'Engine View' button 'E' to switch to the 'Engine' display mode.

In the 'Cylinder' mode (i.e. button in inner position) all observations of the selected cylinder are shown in one view, while in the 'Engine' mode (i.e. button in outer position) only one observation per cylinder of all cylinders is shown in one view, i.e. the last observation made on each cylinder.

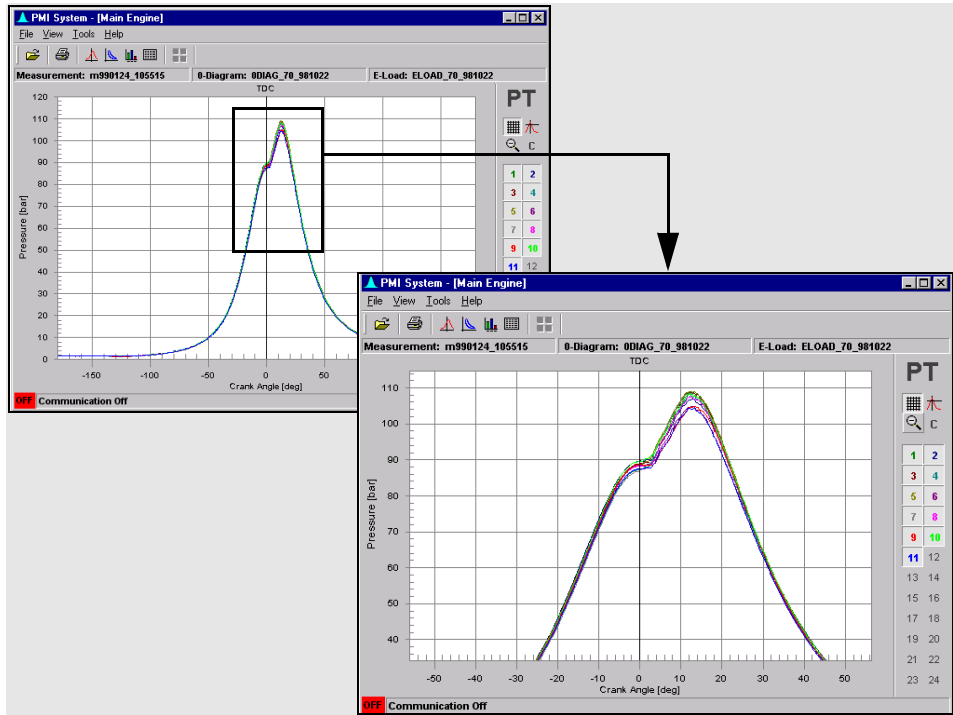

Fig. 3-8. Zooming-in on a PT Diagram

3.6 PV Diagrams



A 'PV Diagram' is shown in Fig. 3-9 and can be displayed either by selecting it in the 'View' menu or by clicking on the corresponding button in the Toolbar.

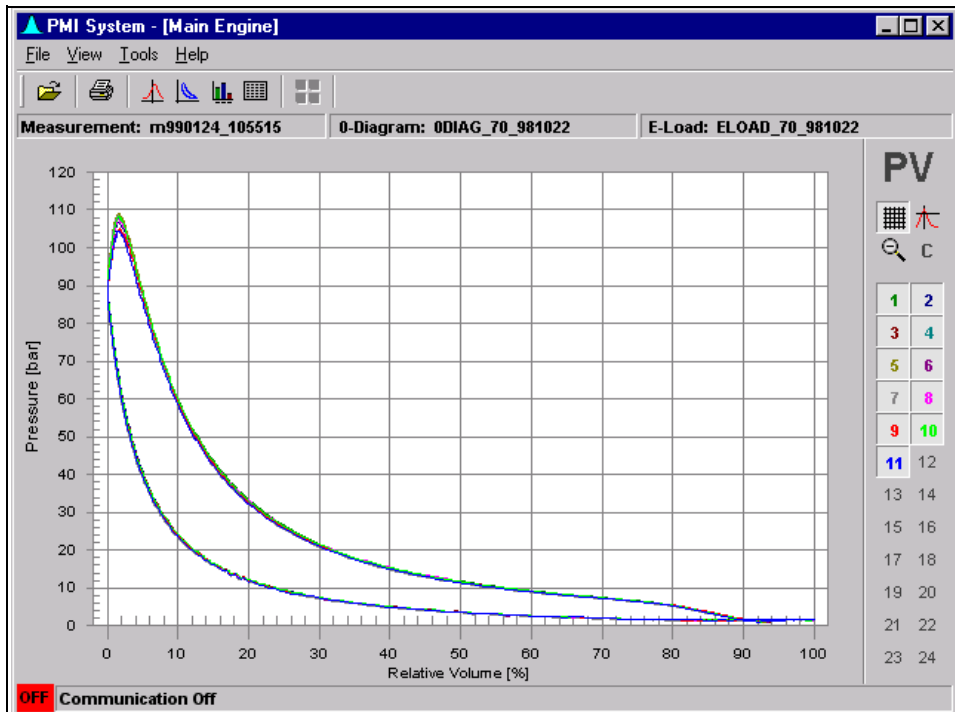

Fig. 3-9. A PV Diagram

The 'PV Diagram' shows the cylinder pressure [bar] as a function of the relative volume [%] of the cylinder. The area contained by the curve is proportional to the work done during the work cycle.

As with the PT Diagram, the PV Diagram is equipped with a Tool Panel. This also has buttons for toggling the display grid, display cursor, zoom, etc., which function in precisely the same manner as described earlier for the PT Diagram. See [section 3.5](#).

3.7 Balance Plots



Also included in the 'View' menu is the 'Balance Plot' command. This provides a bar chart presentation of the combustion pressures of the respective

cylinders of an engine and therefore is a useful indicator of the cylinder pressure distribution or balance of the engine.

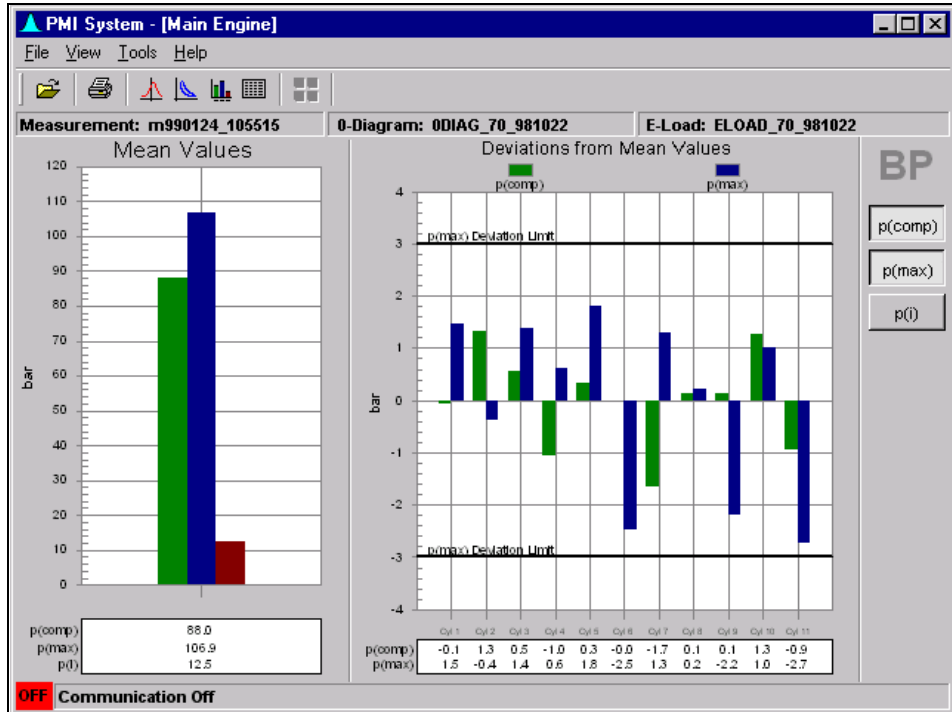

Fig. 3-10. A Balance Plot

A typical 'Balance Plot' is shown in Fig. 3-10. The compression pressure p_{comp} , the maximum pressure p_{max} and the mean indicated pressure p_i of the cylinders are shown and can be individually toggled 'On'/'Off' or 'Off'/'On' by clicking on the corresponding buttons provided on the right-hand side of the display.

On the left of the display is given the mean pressure (i.e. arithmetic average of the individual cylinder pressures combined), while on the right of the display the difference between the actual pressure measured and the mean pressure (i.e. deviation from mean) is indicated for each cylinder.

3.8 Calculated Values



Selecting the 'Calculated Values' in the 'View' menu, opens display schemes similar to those shown in Fig. 3-11 and Fig. 3-12. The same schemes can also be opened by clicking the 'Calculated Values' button in the Toolbar.

Cylinder Number	p(comp) [bar]	p(max) [bar]	Engine Speed [rpm]
1	35,3	39,4	538,1
2	35,7	41,0	538,1
3	35,3	40,9	538,1
4	35,1	38,0	538,1
5	36,4	36,4	538,1
6	36,5	37,4	538,1
Mean	35,7	38,8	538,1
	p(scav)	1,00 bar	

Fig. 3-11. A 'Calculated Values' scheme for a four stroke diesel engine

The schemes give values for the Compression Pressure p_{comp} , the Maximum Pressure p_{max} and the Speed for four and two stroke engines. The latter cover two stroke engines with 'Shim', 'VIT' and 'ME' adjusted fuel pumps and also gives the Mean Indicated Pressure p_i , the Scavenge Air Pressure p_{scav} and the Effective Power for such engines, plus the p_{comp}/p_{scav} ratio for the 'ME' type



Also, included in the two stroke engine schemes are calculated values for fuel pump index adjustments. These show how much the index of each of the cylinders must be adjusted to get the engine properly balanced and are selected by clicking on the 'Index Adjustments' button at the top of the tool panel of the schemes.

With 'VIT' and 'Shim' adjusted fuel pumps the results are expressed as an 'Index Adjustment' (i.e. change of index), as well as in terms of a 'Rotation of link' (i.e. the number of turns required to obtain a certain displacement of the rod) or the number of shims to be inserted or removed.

In contrast with 'ME' pumps, calculated values for $p(i)$, $p(max)$ and $p(comp)/p(scav)$ adjustments are given for direct entry on the main operating panel of the engine. To obtain details about these adjustments, a $p(scav)$ value must be keyed in with the 'Edit Measurement' dialogue. See Fig. 4-7.

To help you assess the effect of the above adjustments on the mean indicated pressure p_i and mean maximum pressure p_{comp} of the engine before actually applying them, the calculated 'Mean' and 'New Mean' pressures are listed directly above one another.

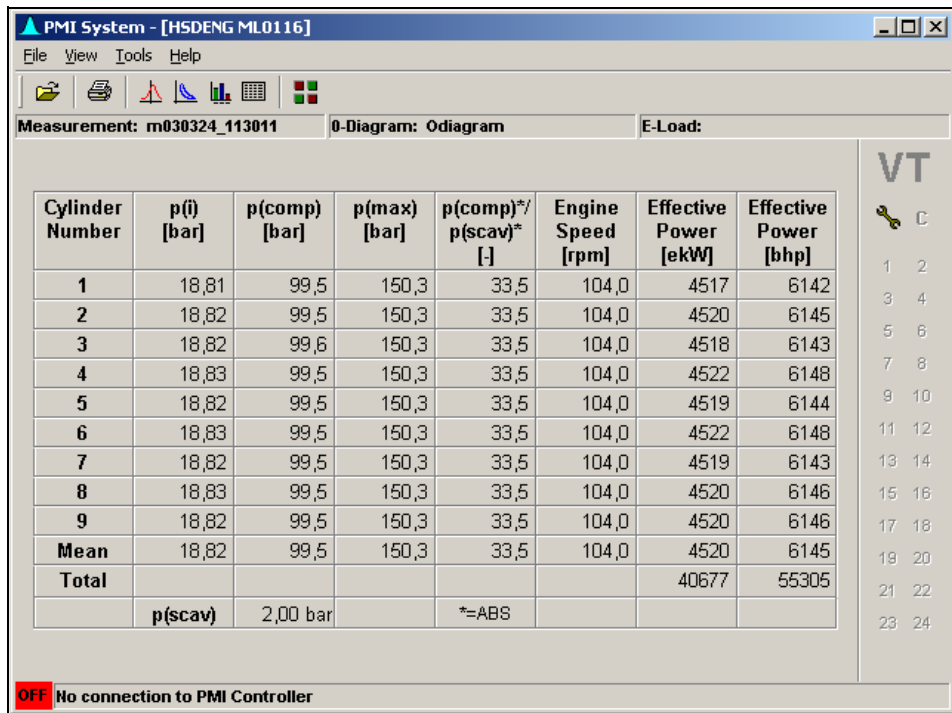

Fig. 3-12. A 'Calculated Values' scheme for a two stroke 'ME' diesel engine. 'Index Adjustments' can be viewed by pressing a tool panel button and moving the scheme with the scroll bar

Pressure Measurements

This chapter explains how to make pressure measurements with the PMI System. Also details are given about how to edit and delete measurements, as well as how to backup and restore the measurement database of the system.

In this Chapter

- **Making Pressure Measurements** . 4-2
- **Checking & Editing Measurements** 4-4
- **Deleting Measurements** 4-8
- **Backing Up & Restoring the PMI Database** 4-9

4.1 Making Pressure Measurements

For making pressure measurements on two and four stroke diesel engines, the PMI System should be used as follows:

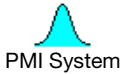

1. Switch on the PC and start the PMI Program by clicking on the PMI System icon on the windows desktop.

The main window of the PMI System should now appear as indicated in [Fig. 3-1](#).

2. Check that the correct engine is shown in the title bar of the main window.

If not, open the engine by selecting 'Open Engine' in the 'File' menu and select it in the dialogue which is opened.

3. Select 'Communication On' in the Tools menu.

The PMI Program will now check communication, but the result of this check can be ignored at this stage as the PMI Controller has not yet been connected.



4. Select 'Measure Status' in the 'View' menu or the corresponding tool in the toolbar.

The view in [Fig. 4-1](#) will now appear which shows a series of panels, one for each cylinder of the engine.

Initially, the panels are coloured grey, but change to green after measurement on the corresponding cylinders has been completed. In addition, the number of observations made on each cylinder is indicated on the panels.

5. Connect the Pressure Transducer to the PMI Controller and the multipole plug of the PMI Controller to the Junction Box. See [Fig. 2-2](#) and [Fig. 4-2](#).

Caution: Always connect the Pressure Transducer to the PMI Controller before connecting the Controller to the Junction Box. Connecting the Transducer while powering the Controller can damage the Controller.

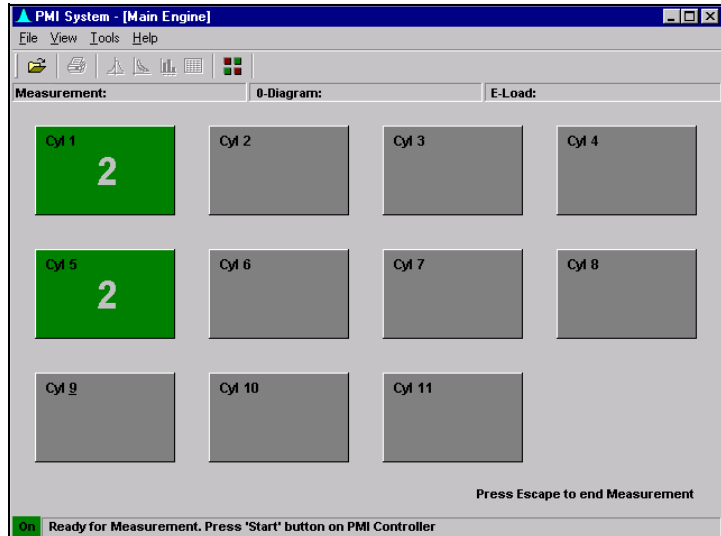

Fig. 4-1. The 'Measurement Status' view

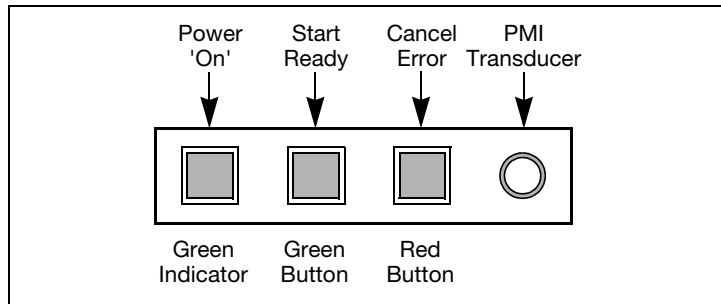

Fig. 4-2. The top panel of the PMI Controller box.

6. Wait until the engine is running with a even load and is stable.
The PMI System is ready for measurements when the green light on the PMI Controller begins to flash repeatedly.
7. Mount the Pressure Transducer on the indicator cock of Cylinder No. 1 and open the indicator cock.

Note: When measuring on four stroke engines it is important to start with cylinder No. 1 to ensure correct identification of each cylinder by the system.

8. Press the green 'Start' button on the PMI Controller to start the measurement.

When the green light lights again, the measurement will have been completed.

9. Close the indicator cock and remove the Pressure Transducer.

 **Warning:** Always check that the indicator cock is closed before removing the transducer. Failure to do this can result in release of extremely hot combustion gasses which can severely injure personnel.

10. Repeat steps 7 to 9 until you have completed measurements on all cylinders.
11. Return to the PC and stop measurements by pressing Esc. on the keyboard or by selecting 'End Measurement' in the 'Tools' menu.

Alternatively, you can stop measurements by unscrewing the multipole plug of the PMI Controller from the Junction Box. This is useful if you want to make another set of measurements before returning to the PC. To be able to do this it is important that you unscrew the plug only when the green 'Start' button is lit and that you wait at least 10 seconds before reconnecting the plug.

Stopping measurements automatically stores them in the PMI System's database.

4.2 Checking & Editing Measurements

On completing one or more sets of pressure measurements, the measurements should be inspected using the 'Open Measurement', 'Edit' function.

To do this, proceed as follows:



1. Activate 'Open Measurement' in the 'File' menu.

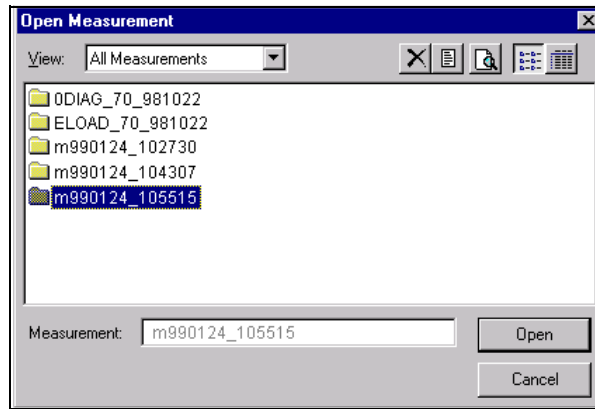

Fig. 4-3. The 'Open Measurement' dialogue as viewed with the 'List' function

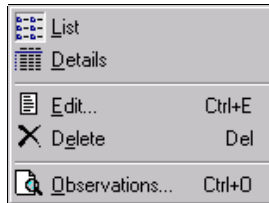

Fig. 4-4. The quick-access menu which is available by right-clicking the mouse in the 'Open Measurement' dialogue

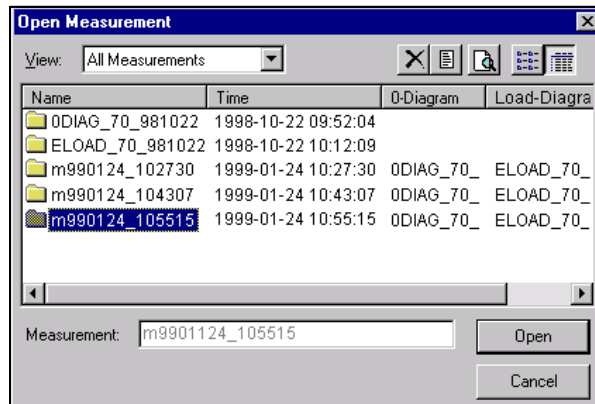

Fig. 4-5. The 'Open Measurement' dialogue as viewed with the 'Details' function

This opens the 'Open Measurement' dialogue shown in Fig. 4-3 which lists all the measurements made with the PMI System.

The most recent pressure measurements are listed with the prefix 'm' and have the date and time of storage as part of their designation.

e.g. m990124_102730.



To view details about the measurements (see Fig. 4-5), right-click anywhere in the dialogue to actuate its quick-access menu and then select 'Details' (see Fig. 4-4). Alternatively, click on the corresponding button in the dialogue's toolbar.



2. Select the particular measurement that you want to examine by left-clicking its name with the mouse and then activate the 'Observations...' command in the quick-access menu or click the corresponding button in the dialogue's toolbar.

Activating 'Observations' opens the 'Edit Cylinder Observations' dialogue shown in Fig. 4-6.

By clicking on the '+/-' symbol shown at the start of each cylinder heading you can expand or contract a heading.

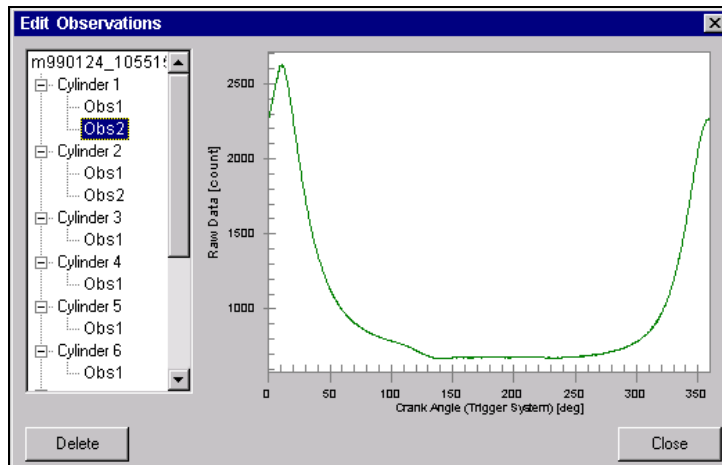

Fig. 4-6. The 'Edit Cylinder Observations' dialogue

To examine an observation, click on its heading. Its pressure curve is then displayed on the right-hand side of the dialogue.

3. Check the observations listed for each cylinder of the engine.

If more than one observation is available per cylinder, it is possible to delete those which are not needed by selecting them and pressing the 'Delete' button at the bottom of the 'Edit Cylinder Observations' dialogue. See [Fig. 4-6](#).



4. Next click the 'Close' button to return to the 'Open Measurement' dialogue and then activate the 'Edit' command in the dialogue's quick-access menu or click the corresponding button in its toolbar.

Activating the 'Edit' command opens the 'Edit Measurement' dialogue shown in [Fig. 4-7](#). This allows you to rename the measurement as well as to check whether the measurement is linked with the appropriate '0-Diagram' and 'E-Load' reference measurements.

5. To rename the measurement, click in the measurement field and key in a new name.

For this purpose a naming convention which preserves the date and time of the measurement is suggested.

e.g. m_70_990124_1055

Where the first character 'm' indicates a measurement, the next three characters indicate the engine load, the next seven characters the date and the last five characters the time that the measurement was stored.

6. Next check that the names of the appropriate '0-Diagram' and 'E-Load' measurement files which are to be used for TDC determination, appear in the list-boxes immediately below the name of the measurement.

If no '0-Diagram' and 'E-Load' files are listed, then the appropriate measurements must be made as explained in the “Commissioning” Chapter of the Installation Guide for the PMI System.

7. Finally, key in the appropriate value for the scavenge air pressure of the engine in the 'p(scav):' data field and press the 'OK' button to close the 'Edit' dialogue and save your changes to the measurement.

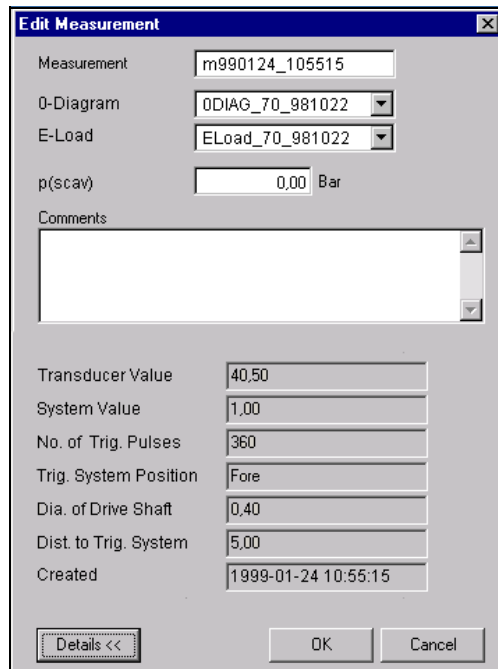

Fig. 4-7. The 'Edit Measurement' dialogue

Note: If no scavenge air pressure reading is keyed in, then the program itself will automatically estimate it. To force estimation the 'p(scav):' data field must be set to '0' or '0.00'.

After having checked and accepted a measurement as described above, it may be examined in more detail using the 'View' menu commands which are explained in [section 3.5](#) to [3.8](#).

4.3 Deleting Measurements



To delete measurements which are no longer needed, the 'Open Measurement' command in the 'File' menu includes a 'Delete' function. This may be activated either by clicking on the tool button shown or by selecting the command in the dialogue's quick-access menu.

4.4 Backing Up & Restoring the PMI Database

For optimum security, we recommend that you frequently take a backup copy of the PMI database to help safeguard your measurement data. For this purpose a backup copy can be saved on the hard disk of your PC using the dialogue shown in Fig. 4-8.

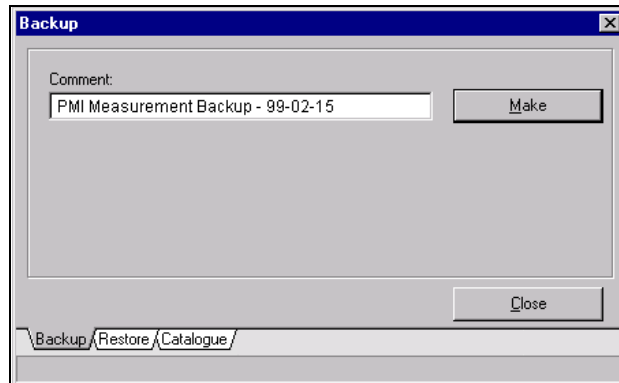

Fig. 4-8. The 'Backup' dialogue

The 'Backup' dialogue is opened using the 'Backup' command in the 'File' menu. To commence backup, click on the 'Make' button. The PMI System then responds with the name and location of the new file which is to be used for storing the backup on your hard disk. To accept the file and continue with backup, click on the 'Yes' button. The PMI System then takes a copy of database and stores it on the hard disk.

In addition to the above, the 'Backup' dialogue has functions for restoring the PMI System database and deleting backup files, as well as saving and getting them from elsewhere, such as on floppy disks or other external media. These functions are included on the 'Restore' and 'Catalogue' tabs of the 'Backup' dialogue (see Fig. 4-9 and 4-10). When backup files are created they are stored in compressed form and are automatically decompressed whenever they are used to restore the PMI System's database.

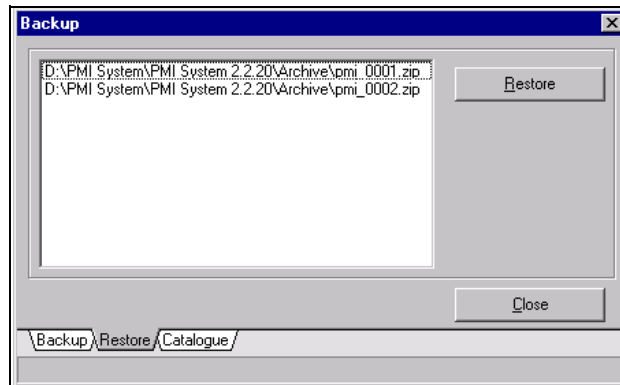

Fig. 4-9. The 'Backup > Restore' dialogue

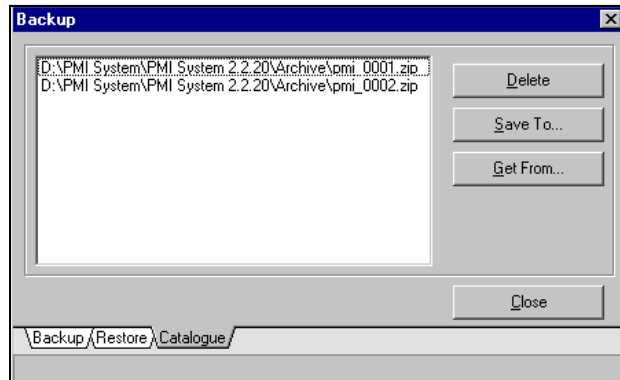

Fig. 4-10 The 'Backup > Catalogue' dialogue

Note: When restoring the database it is important that the appropriate backup file is selected (i.e. is highlighted) in the 'Backup > Restore' dialogue.

Restoring data files from a backup copy of the data base will overwrite existing data. Therefore to reduce the risk of losing recent measurements and other data, always take a backup copy before attempting to restore the data base.

PMI Menus & Commands

This Chapter provides a brief overview of the commands and other functions which are available with the menu bar of the PMI System and includes reference to keyboard shortcuts and toolbar buttons.

In this Chapter

- **File Menu**..... 5-2
- **View Menu**..... 5-2
- **Tools Menu**..... 5-3
- **On-line Help** 5-4
- Help Menu 5-4
- Function Key F1 5-5

5.1 File Menu

- **Open Engine ...:** Opens the 'Open Engine' dialogue for selecting specific engines for pressure measurements and viewing measurement results. See [section 3.3](#) for further details.



- **Open Measurement ...:** Opens the 'Open Measurement' dialogue for selecting 'All', 'New' and 'Old' measurements for the particular engine chosen with the 'Open Engine' command specified above. See [section 3.4](#) for further details.

Shortcut: 'Open Measurement' can also be chosen using Ctrl. + O.

- **Close Measurement:** Closes the current measurement view leaving the currently selected engine open.
- **Backup...:** Opens the 'Backup' dialogue for making a backup copy of the PMI System database on the hard disk of your PC. It is also used for restoring the PMI System database and for archiving/cataloguing files. See [section 4.4](#) for further details.



- **Print:** Prints the content of the window which is currently activated.
- **Print Setup ...:** Opens the 'Print Setup' dialogue for selecting printer, printer properties, page orientation, page size and other page set-up options.
- **Exit:** Closes the PMI System.

Shortcut: 'Exit' can also be chosen using Alt. + F4.

5.2 View Menu



- **PT Diagram:** Displays the PT Diagram of current engine, i.e. the cylinder pressure versus time (i.e. crankshaft angle) diagram. See [section 3.5](#) for further details.



- **PV Diagram:** Displays the PV Diagram of current engine, i.e. the cylinder pressure versus relative volume diagram. See [section 3.6](#) for further details.



- **Balance Plot:** Displays the balance plot of the mean pressure, as well as the difference between the actual pressure measured and the mean pressure indicated for each cylinder. See [section 3.7](#) for further details.



- **Calculated Values:** Displays a list of calculated measurement values for all cylinders. Also includes proposed values for Index Adjustment. See [section 3.8](#) for further details.



- **Measuring Status:** Indicates the current status of each measurement, as well as the cylinder order and number of measurements performed. See [section 4.1](#) for further details.

5.3 Tools Menu

- **Communication:** For enabling ('✓' mark beside menu item) and disabling communication between the PMI program and the PMI Controller. If the program fails to establish communication, then it is automatically set 'Off-line' for viewing stored measurements. See [section A.4](#).
- **Test System:** Checks communication to the PMI Controller and tests the trigger system. See [section A.4.3](#).
- **Start Measurement:** Checks communication with the PMI Controller and starts the measurement sequence if the PMI Controller is connected.
- **End Measurement:** Stops measurement.
- **Communication Log...:** Opens the 'Communication Log' which keeps a record of all communication checks made between the PMI System and the PMI Controller.
- **Options ...:** Opens the 'Options' dialogue for setting up communication port, transducer calibration, measuring period and single or double triggering. See [section A.4.1](#).

- **TDC Values ...** : Displays the crank angle offset plus measured crank angles corresponding to the TDC of the respective cylinders. For display select the latest '0-Diagram' measurement for the current engine from the opening dialogue. The crank angles are stated in radians and degrees.

5.4 On-line Help

The PMI System provides several ways of getting 'On-line Help'. You can use either the 'Help' menu or the function key F1.

5.4.1 Help Menu

To help you determine which menu commands are used to access specific topics, the respective menu commands are listed below:



- **Contents:** Displays the 'Help Contents'. This is the most detailed source of information and clicking on the respective items listed provides information on the following topics:
 - **Using Help:** How to use the Windows Help System together with the PMI System's 'On-line Help'. Also, includes Windows Help Index and search engine for finding specific topics.
 - **Screen:** The PMI System screen structure, including definitions of its main components.
 - **Commands:** The PMI System commands, keyboard and mouse functions, menus and toolbar.
 - **Tools:** The function of the different buttons seen in the 'Toolbar' of the PMI System.
 - **How to...:** The operating instructions for using the PMI application software and hardware.

- **Keyboard:** The keys and key combinations associated with the PMI System commands.
- **Glossary:** A glossary explaining the PMI System and other related terms.

At the top of the 'Help Contents' window is a row of five keys. These select the following:

- **Help Topics:** Opens the 'PMI Index and Find' dialogue, enabling you to search for and display any topic by keying in its name or by clicking on a topic listed in the dialogue.
- **Back:** Returns the 'Help' window to the previous view or topic.
- **Print:** Prints the current view or topic.
- **Glossary:** Lists a 'Help Glossary', explaining about the PMI System and other related terms.
- **Close:** Exits the 'Help' window.

The remaining commands contained in the 'Help' menu are as follows:

- **Search for Help On...:** Opens the 'Index and Find' dialogue for finding specific topics about the PMI System.
- **How to Use Help:** How to use PMI System's 'On-line Help'. For example, how to find, copy and print information, as well as customise help.
- **About ...:** Displays the name, version and build number, as well as copyright information concerning the PMI System software which is installed on your PC. Also information is provided about where and how to get product support: on-line, in printed documentation or by contacting MAN B&W Diesel.

5.4.2 Function Key F1

Whenever in doubt about any command or function that you are using, press the Function Key F1 at the top of the keyboard. This will immediately provide you with context sensitive help information about the partic-

ular command or function that you are using in the particular situation that you are using it.

To access context sensitive information about a menu item, you can use either the keyboard alone or the mouse together with the keyboard.

To use the keyboard, first press the 'Alt' key and the first letter of the main menu that you wish to examine, and then use the arrow keys to select the particular command of interest in the menu and press the 'F1' key to activate context sensitive help.

If you use the mouse, click on the name of the main menu and while keeping the mouse button pressed, select the command of interest and press the function key 'F1' on the keyboard.

Note: Keep the mouse button pressed until you have activated the 'F1' key.

Similarly you can also get context sensitive help on other items displayed in the main window, e.g. views, menus, dialogues, etc. In addition, by pointing the mouse at the buttons in the Toolbar you can obtain hints about the purpose of the individual buttons. These are flagged just below each button and explain what will happen when you click on a tool.

Appendix

In this Appendix

• Technical Specification	A - 2	• Maintenance Checks & Adjustments	A - 11
Off-line PMI System	A - 2	Angle Encoder	A - 11
Computer Requirements.....	A - 3	LE-Pickup	A - 13
• Software Installation	A - 3	PD-Pickup.....	A - 15
• Care & Handling of Equipment	A - 4	• Troubleshooting	A - 16
• System Checks	A - 6	• Technical Assistance	A - 22
Communication Options	A - 6		
Engine Address	A - 7		
Trigger Test	A - 8		

A.1 Technical Specification

A.1.1 Off-line PMI System

Engine Types:

All two & four stroke MAN B&W diesel engines with up to 24 Cylinders

Engine Speed:

Up to 900 rpm

Pressure Range:

0 to 225 bar

Measurement Modes:

PT, PV and Balance Diagrams giving Mean Indicated Pressure p_i and Maximum Pressure p_{max} deviation limits

Calculated Values:

Two-stroke: Effective Power, Mean Indicated Pressure p_i , Compression Pressure p_{comp} , Maximum Pressure p_{max} , Scavenge Air Pressure p_{scav} , Index Adjustments, etc.
Four-stroke: Compression Pressure p_{comp} , Maximum Pressure p_{max} and Scavenge Air Pressure p_{scav}

Overall Accuracy:

$\pm 3\%$

Repeatability:

$\pm 1\%$

PC Software:

CD-ROM

System Hardware:

Pressure Transducer
PMI Controller
Junction Box
Intermediate Box
Converter Box
TDC & Crank Angle Pickups: Angle Encoder
Light Emitting Pickup
or Proximity Detector Pickup

Power Requirements:

Supply Voltage: 24 V DC nominal (18 to 32 V)
Consumption: 800 mA

Operating Temp.:

PMI Controller: 50°C max.
Transducer: 350°C max. short term use

Mass:

PMI Controller: 3.15 kg including cable
Transducer: 0.72 kg including adaptor

A.1.2 Computer Requirements

Hardware:

To obtain full advantage of the PMI System and its many features, MAN B&W Diesel recommends the following minimum system configuration:

- IBM PC or 100% IBM compatible computer
- Pentium II Processor, or later
- 32 MB RAM
- Hard disk with 500 MB free space available
- SVGA video adaptor
- CD-ROM drive
- Floppy drive for 3.5 inch HD (1.44 MB) diskettes
- Mouse
- 17 inch SVGA Colour Monitor
- Printer
- Free Com. Port – 1, 2, 3 or 4

Software:

- Microsoft® Windows NT 3.5.1, Windows 95™ or later

A.2 Software Installation

The PMI software is normally supplied on a CD, containing both the PMI application program and engine specific data concerning your diesel engine plant.

To install the PMI program and its data:

1. Insert the CD in your CD-ROM drive.

2. Open the 'Start' menu in the bottom left corner of the display and choose 'Run'.
3. Type d:\setup.exe. (If your CD-ROM Drive is not letter D, type the appropriate letter instead.)
4. Select OK.
5. Follow the instructions on screen.

With WIN NT 3.5.1, WIN95, or later, the installation software will automatically install a 'PMI System' icon on the Window's desktop for opening the program. In addition, it will be listed in the programs menu and sub folder contained in the 'Start' menu.

A.3 Care & Handling of Equipment

The PMI System uses a high performance pressure transducer which is recognised for its excellent performance and stability in a wide variety of environments where relatively high levels of mechanical vibration as well as temperatures up to 350°C exist. However, like other measurement devices it should be handled with care in order to preserve its measurement performance and accuracy. Therefore, whenever using the transducer and associated equipment, always heed the following:

- **Storage:**

When not in use the transducer should be returned to its original packaging and stored at room temperature (~20°C). In addition, its output connector should be fitted with the plastic protection cap provided.

- **Handling:**

Avoid hitting or dropping the transducer as this can subject it to mechanical shock well outside its design limits and can severely damage it.

- **Mounting:**

Avoid over tightening the transducer when mounting it on the cylinder indicator cock. Always tighten it by hand without using a spanner. Also,

only open and close the indicator cock whilst the transducer is connected and always remove the transducer immediately after completing each measurement.

Warning! Leaving the transducer permanently mounted on the indicator cock will severely damage it.

- **Connections:**

The output connector of the transducer, including the corresponding plugs and sockets of the connecting cable and the PMI Controller, should be kept clean and free of oil and grease at all times. When not in use they should be fitted with the plastic protection caps provided.

The multipole connector used to couple the PMI Controller to the Junction Box should be treated with care. Whenever plugging or unplugging it from the Controller, it is important to turn the outer part of the connector so as to lock or unlock it from the Controller. Avoid using tools on the connector.

If the connectors need cleaning, then only use dry, chemically clean, pressurised air, such as that used for cleaning photographic equipment.

Caution: Never use compressed air from ship or generator plant outlets as they contain oil. Similarly, avoid using chemical cleaning agents, as they will damage the ultra high impedance insulation of the connectors and cable.

- **Calibration:**

Where the pressure transducer is subjected to frequent handling as when used for regular performance measurements and surveys on diesel engine plant, we recommend that it is checked and recalibrated every 12 months. Also if at any time the transducer appears to have been physically damaged in any way or that there is partial or complete loss of output signal from the transducer, then it should be replaced and the PMI System readjusted in accordance with the sensitivity of the new transducer. See [section A.4.1](#) below.

Important Note: Where the PMI System is used for onboard surveys in connection with the "IMO – NOx Technical Code", it is the

responsibility of the operator to ensure that the apparatus (sensors and gauges) are correctly adjusted and calibrated in accordance with the manufacturers instructions. For details, please refer to the "IMO – NOx Technical Code".

A.4 System Checks

If the PMI System fails to establish communication with the particular engine that is selected, then it is likely that the appropriate communication options have not been chosen or that the engine's address setting is incorrect.

A.4.1 Communication Options

Communication between the software and hardware of the PMI System is set up using the 'Options' dialogue shown in Fig. A-1. This dialogue is opened by selecting the 'Options' command in the 'Tools' menu and should be set as follows:

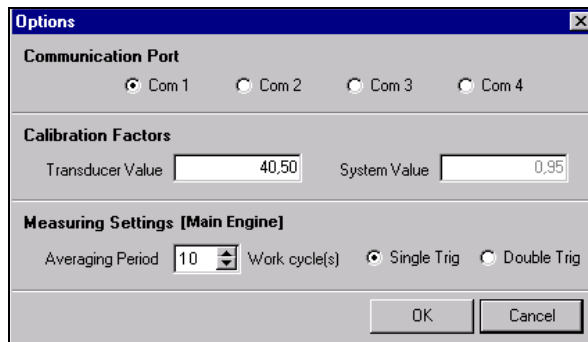

Fig. A-1 The 'Tools' menu 'Options' dialogue

Communication Port: 1, 2, 3 or 4, depending on which port of the PC is coupled to the Converter Box of the PMI System.

- Calibration Factors:** 'Transducer Value' – The transducer sensitivity at 20 - 23° C and 250 bar, as specified on the calibration chart supplied with the transducer.
- 'System Value' – A fixed value of 0.95 matching the system amplification of the Off-line PMI System.
- Measuring Settings:** 'Averaging Period' – Sets the number of work cycles over which the measurement is averaged. Should normally be set for averaging over 10 work cycles.
- 'Single Trig.' – Normal setting for triggering with an Angle Encoder.
- 'Double Trig.' – Normal setting for other pickups.

A.4.2 Engine Address

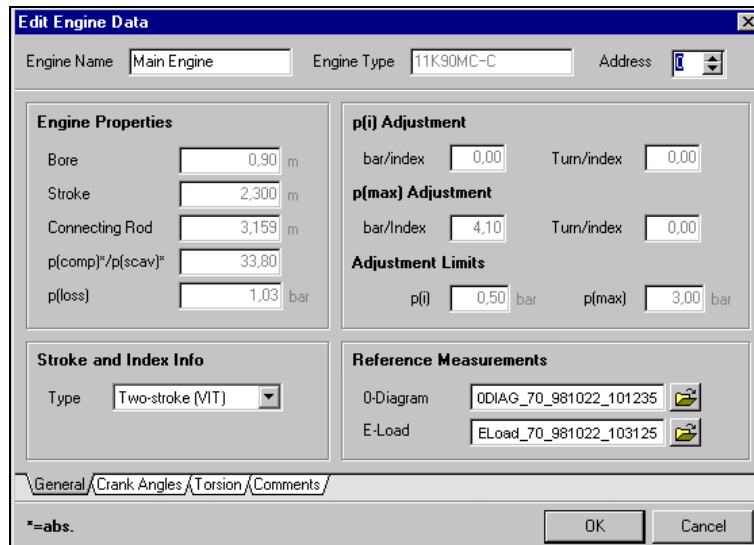

Fig. A-2 'The 'Open Engine > Edit' dialogue

The engine address is shown at the top of the 'Open Engine > Edit Engine Data' dialogue.



To view this dialogue, first select 'Open Engine' in the 'File' menu and click on the name of the particular engine concerned. The 'Edit' dialogue is then opened by clicking on the appropriate tool button at the top of the 'Open Engine' dialogue.

The engine address number should match the SW1 address switch setting in the Junction Box for the engine to be measured – see [Fig. A-11](#).

If they do not match, change the dialogue's address number accordingly. Normally, the engine address should be set as follows:

- always '0' for first engine
- '1', '2', '3', etc. for the second and subsequent engines, irrespective of whether they are two or four stroke.

If after checking the above, the PMI System still fails to communicate with the PMI Controller then it is recommended to check all plug and cable connections en route to the particular engine. See Installation Guide for further details.

For an explanation about other data fields included in the 'Open Engine - Edit' dialogue, see the '[Glossary](#)' at the back of the User's guide.

A.4.3 Trigger Test

On completing communication test, the PMI System automatically starts a Trigger and TDC Test. If stable triggering cannot be achieved, then the PMI System will automatically warn about the situation by displaying the 'Trigger and TDC Test' dialogue shown in [Fig. A-3](#).

The test results indicated by this dialogue are as follows:

- **No. of pulses detected:** This provides a count of the number of crank angle pulses detected per work cycle.

When triggering is stable only one count will be displayed.

If triggering is unstable, then the latest five counts will be listed. See below to help determine the cause.

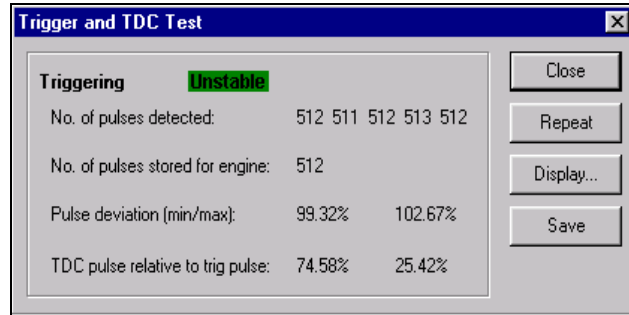

Fig. A-3 The 'Trigger and TDC Test' dialogue

- **No. of pulses stored for engine:** The crank angle pulse count that was obtained when triggering was last stable.
- **Pulse deviation (min./max):** Gives the minimum and maximum percentage deviation of the crank angle pulses relative to their mean repetition time.

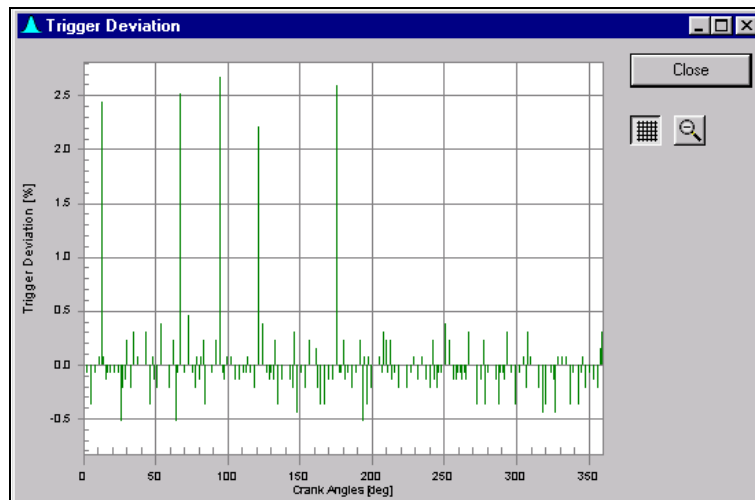

Fig. A-4 The 'Trigger Deviation' dialogue

Large deviations indicate a dirty pickup or a defective trigger system. See [section A.5.1](#) through to [A.5.3](#).

To obtain a graphic view of the trigger pulse deviation, click on the 'Display' button in the dialogue. See [Fig. A-4](#).

- **TDC pulse relative to trigger pulse:** Indicates relative position of the leading edge of the TDC pulse with respect to the start and end of the crank pulse period (see [Fig. A-5](#)). For correct synchronisation the leading edge must be positioned between 15 and 85% of the crank pulse period.

If either of the readings is less than 15% or greater than 85%, then the pickup is not correctly adjusted or is defective. See [section A.5.1](#) through to [A.5.3](#), which ever is appropriate for the type of pickup.

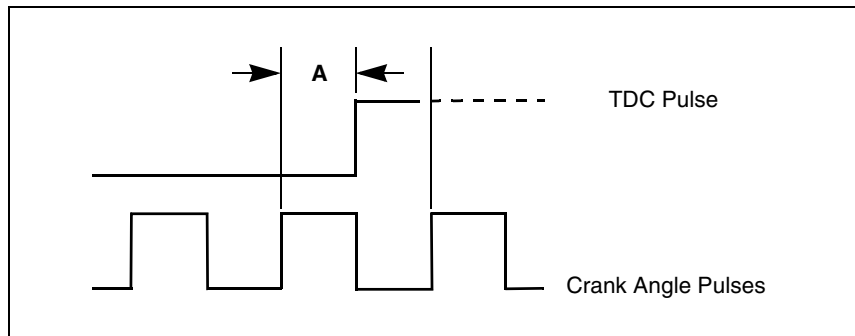

Fig. A-5 Timing of the TDC and Crank Angle Pulses

Repeating the Trigger Test:

To repeat the Trigger Test, click on the 'Repeat' button in the dialogue.

Storing Trigger Test Count:

When testing has been completed and the system has been cleaned or re-adjusted to provide stable trigger pulse count, click on the 'Save' button in the dialogue. This will store the pulse count for use in subsequent trigger tests.

For multi engine plants, repeat [section A.4.1](#), [A.4.2](#) and [A.4.3](#) to check communication and triggering with the other engines.

A.5 Maintenance Checks & Adjustments

A.5.1 Angle Encoder

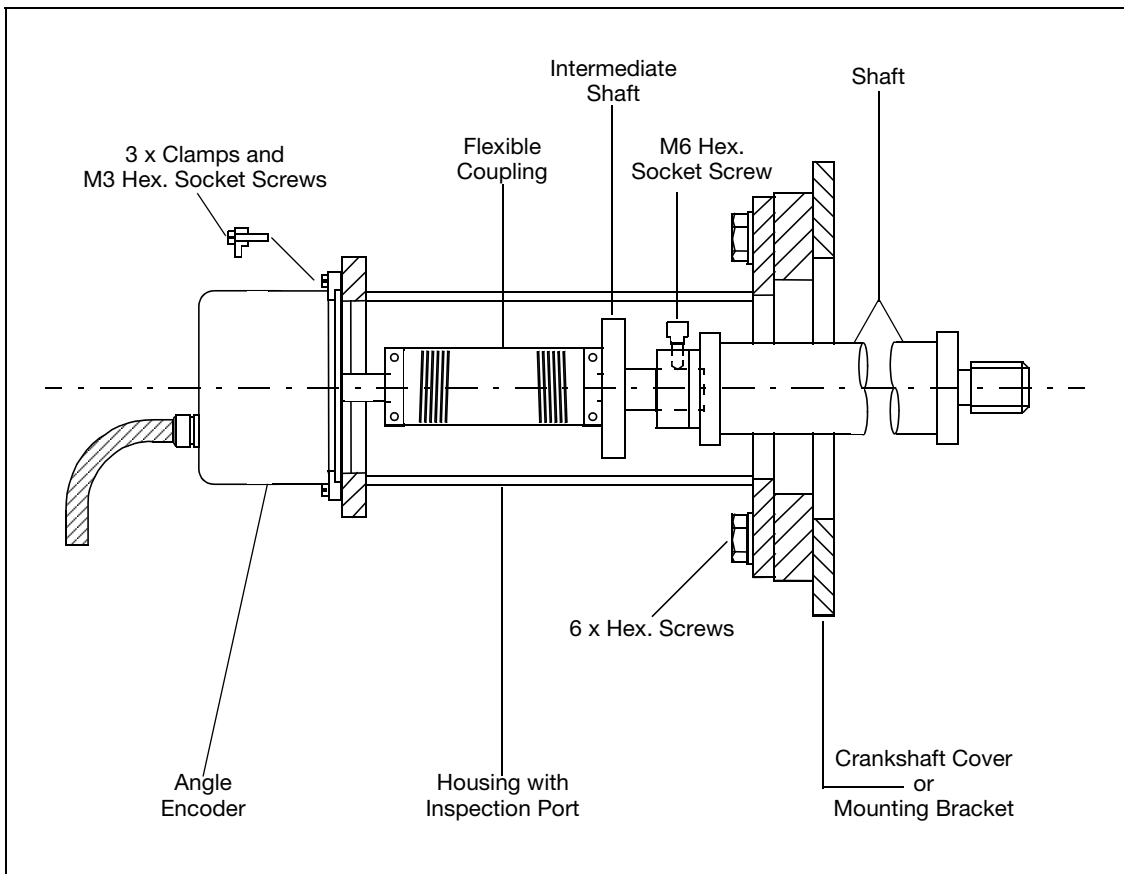

Fig. A-6 Mounting of the Angle Encoder

In installations which employ an Angle Encoder for crank angle triggering, the following checks and adjustments should be made if the PMI System fails to trigger correctly:

- **TDC Pulse Synchronisation:**

1. Engage the turning gear and turn the engine until cylinder No. 1 is at TDC as indicated on the turning wheel.

The green indicator light should now be lit on the Intermediate Box. If not, carry out steps 2 to 5 below.

2. Loosen the 3 x M3 hexagonal socket head screws, clamping the Angle Encoder to the Cylindrical Housing at the free end of the crankshaft. See Fig. A-6.
3. Turn the encoder housing by hand, until the green light is lit on the Intermediate Box.
4. Tighten the 3 x M3 hexagonal socket head screws on the Angle Encoder. See [Fig. A-6](#).
5. Check that the green light remains lit. If the light is off, repeat steps 2 to 5 until it remains lit.

- **Engine Vibration:**

Check that the crankshaft cover is firmly mounted on the engine and that the cover does not vibrate excessively. If the cover vibrates, a number of metal ribs should be welded on the cover to stiffen it.

- **Removal and Replacement:**

If any part of the Angle Encoder assembly or crankshaft cover have to be removed for any reason, then the entire assembly must remounted and adjusted again as described in the Installation Guide.

 **Warning:** To avoid injury, shut off the engine and block the starting mechanism before attempting to remove or replace the Angle Encoder.

A.5.2 LE-Pickup

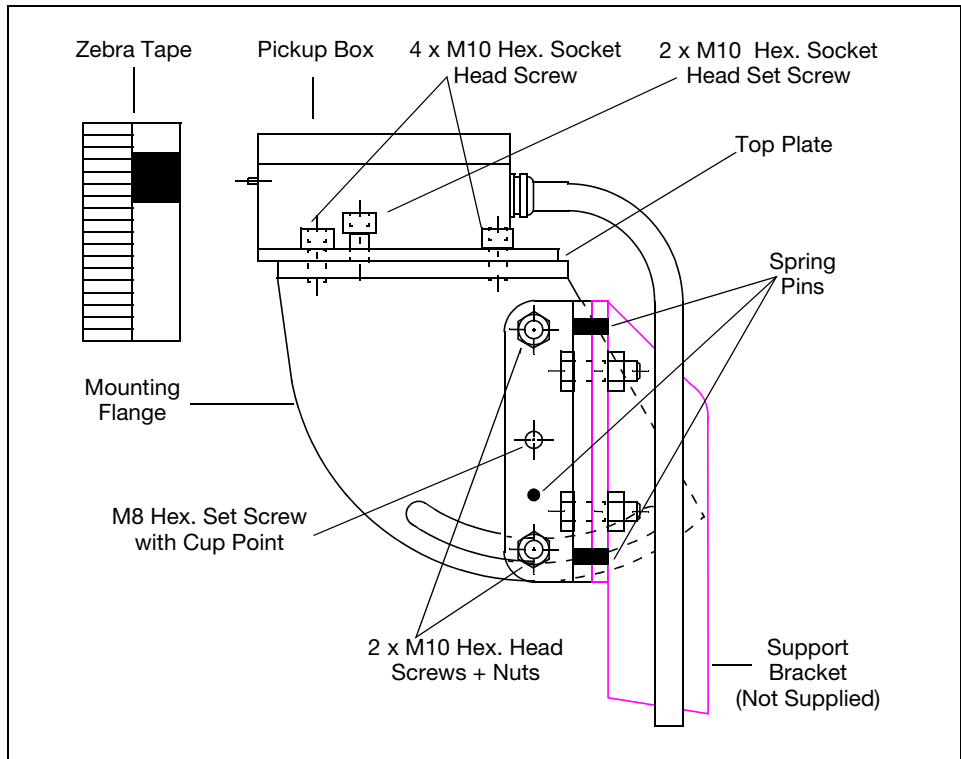

Fig. A-7 Mounting of LE-Pickup on Adjustable Bracket. Certain parts may differ in design and appearance to suit the application

In installations using an LE-Pickup with Zebra Tape for TDC and crank angle triggering, the following checks and adjustments should be made if the PMI System fails to trigger correctly:



1. Apply the following safety precautions:

- Stop the engine
- Block the starting mechanism

- Shut off the starting air supply
 - Engage the turning gear
2. Check that the Zebra Tape which is bonded to the drive shaft is not contaminated by dirt, oil and grease. Clean the surface of the tape using a dry, absorbent cloth.

Caution: Do not use cleaning agents containing chemical solvents or detergents, as these can dissolve the zebra tape, damaging its surface and bonding properties.

3. Check that the pickup is firmly supported and is properly aligned with respect to the stripes on the zebra tape. There should be a clearance of 2 mm between the tips of the pickups and the zebra tape. See [Fig. A-7](#) and [A-8](#) respectively.

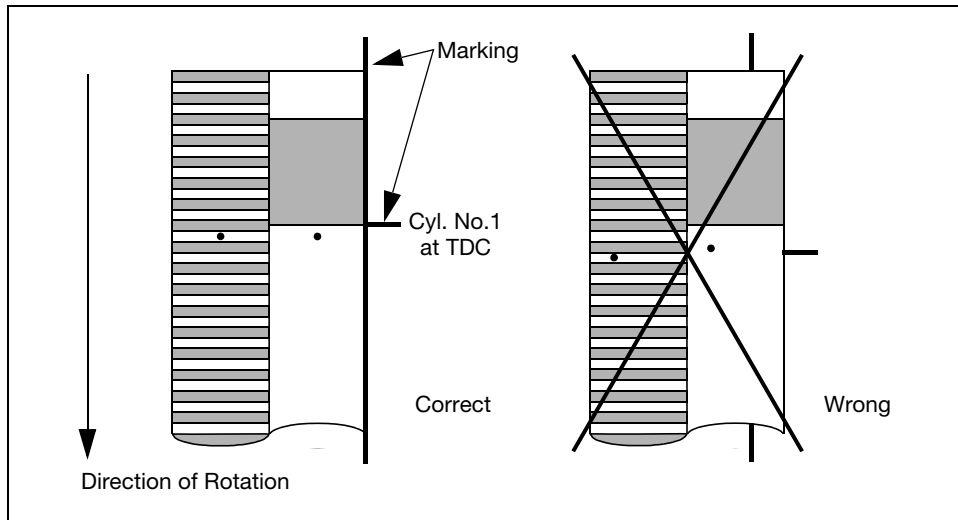

Fig. A-8 Alignment of zebra tape and light dots from the LE-Pickup

4. Check that the LE-Pickup projects two dots of red light on to the zebra tape and that the indicator light on the Intermediate Box continuously flashes when the engine is started and is running stably.

If no light is visible, check the cabling of the PMI System and the adjustment of the amplifiers in the LE-Pickup Box – see Mounting and Installation Guides for details.

A.5.3 PD-Pickup

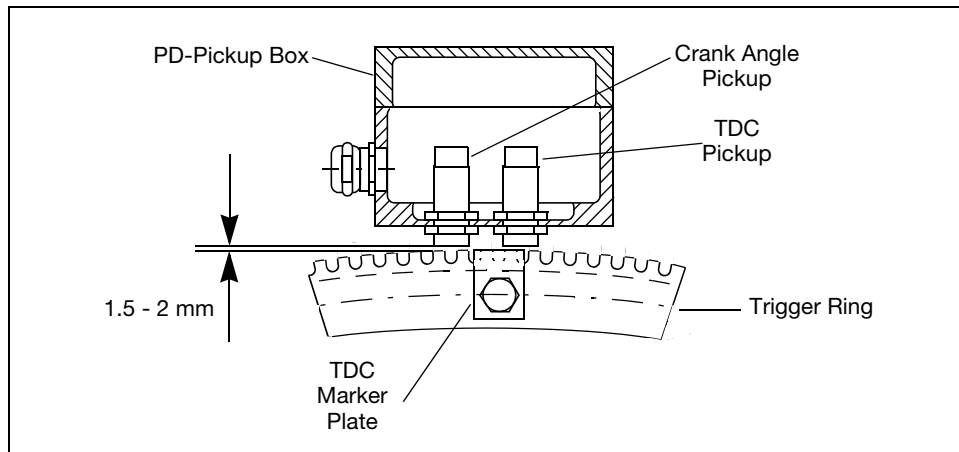

Fig. A-9 Typical PD-Pickup mounting arrangement 1.5 to 2 mm from the teeth of a trigger ring and TDC marker bolted on the ring

In installations which use PD-Pickups for TDC and crank angle triggering, the following checks and adjustments should be made to obtain correct triggering:



1. Apply the following safety precautions:
 - Stop the engine
 - Block the starting mechanism
 - Shut off the starting air supply
 - Engage the turning gear
2. Check that the Pickup Box is firmly fastened and is aligned so that the respective pickups are centred over the teeth of the trigger ring and the

TDC marker bolted on the ring. Also, check that there is 1.5 to 2 mm clearance between the tip of each pickup and the teeth of the trigger ring or marker. See [Fig. A-9](#).

3. Remove the lid of the Pickup Box and check that the indicator lights at the back of the pickups repeatedly flash while the engine is running. If they do not flash, then there is either too little or too much clearance between them and the trigger ring or turning wheel, or they do not function correctly and should be replaced.

For further information about adjustment of the PD-Pickups, consult the PD-Pickup Mounting Guide.

A.6 Troubleshooting

Some of the technical difficulties which might be encountered when first using the PMI System are described below and include useful advice on how to correct them.

Long Measurement Time – 'Error' light blinks on PMI Controller:

The PMI Controller automatically changes its measurement range and restarts measurement whenever the maximum cylinder pressure exceeds approximately 100 bar. When this occurs the red 'Error' light on the control box is momentarily lit and the overall time of the measurement increased by approximately one minute.

On concluding measurement, the green 'Ready' button on the control box should light, indicating that the PMI System is ready to begin another measurement.

If the red 'Error' button continues to blink without the 'Ready' button lighting, then inspect the transducer and PMI Controller plug connections. Dirty connections can interfere with the measurement. See [section A.3](#) for cleaning.

Measurement Failure – 'Error' light remains lit on PMI Controller:

If the red 'Error' button on the PMI Controller remains lit and the error cannot be cancelled by pressing the button, then there is probably a fault with communication or triggering. Activate the 'Communication Log' in the Tools' menu for details. See Fig. A-10.

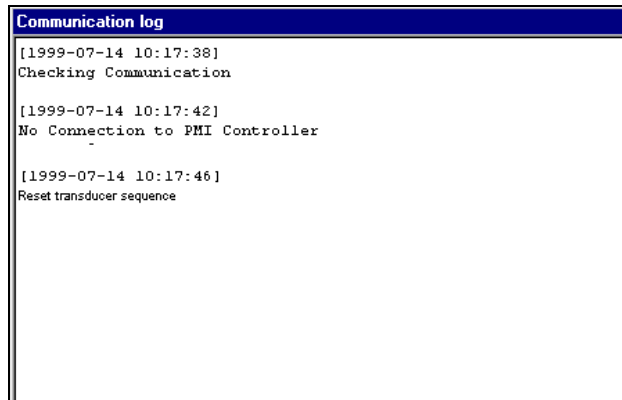

Fig. A-10 The 'Communication Log' dialogue

'Missing TDC Pulses' – Communication Log Warning:

If the 'Communication Log' indicates that the TDC pulses are missing, check that the jumper JP3 in the Junction Box is set to 'On' as shown in [Fig. A-11](#). If this is not successful, check the trigger system as described in [section A.4.3](#) to [A.5.3](#) or in the Installation Guide.

'TDC and Trigger Test Results' Dialogue Displayed on PC:

If at the start or during a measurement the 'TDC and Trigger Test Results' dialogue is displayed on the PC, then it is likely that the TDC and crank angle signals from the crankshaft pickups are not functioning correctly and need to be adjusted to obtain a stable triggering. See [section A.4.3](#) to [A.5.3](#).

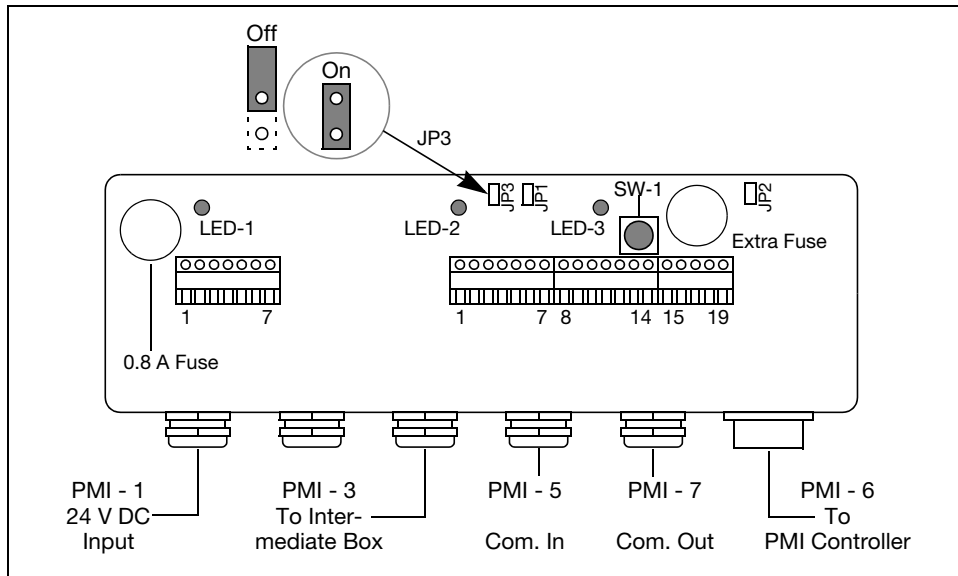

Fig. A-11 Layout of the PMI System's Junction Box

'PMI Controller address does not match stored engine'
Error and Status Line Warning on PC:

If a red marker with the warning “PMI Controller address does not match stored engine” is flagged at the bottom of the display, select 'Open Engine' and the 'Edit' dialogue for the particular engine to which the PMI Controller is connected and then set the engines address to the active engine address stated in the error message which is opened with the status line warning.

'No Connection to PMI Controller' Status Line Warning on PC:

If a red marker with the warning “No connection to PMI Controller” is flagged at the bottom of the display after having set 'Communication On/Off' to 'On', then check the following:

1. Check that the standard plug of the Converter Box indicated in [Fig. 2-2](#) is properly secured to one of the communication ports of the PC and

that the appropriate port is chosen in the 'Tools' menu, 'Option' dialogue on the PC. See [section A.4.1](#).

Junction Box LED No.			PMI Controller	Comments
24 V 1	15 V 2	5 V 3	Power On	
Off	Off	Off	Off	Unscrew and check that the 0.8 A fuse in the Junction Box is intact. An extra fuse is included in the box for replacement. Also check that the 24 V DC power input cable PMI - 1 is connected correctly, as indicated on the print board in the box.
On	Off	On/Off	Off	15 V power regulation is defective. Replace Junction Box.
On	On	Off	On	5 V power regulation is defective. Replace Junction Box.
On	On	On	On	System is OK.

Table A-1 Junction Box – Supply and Cable Checks

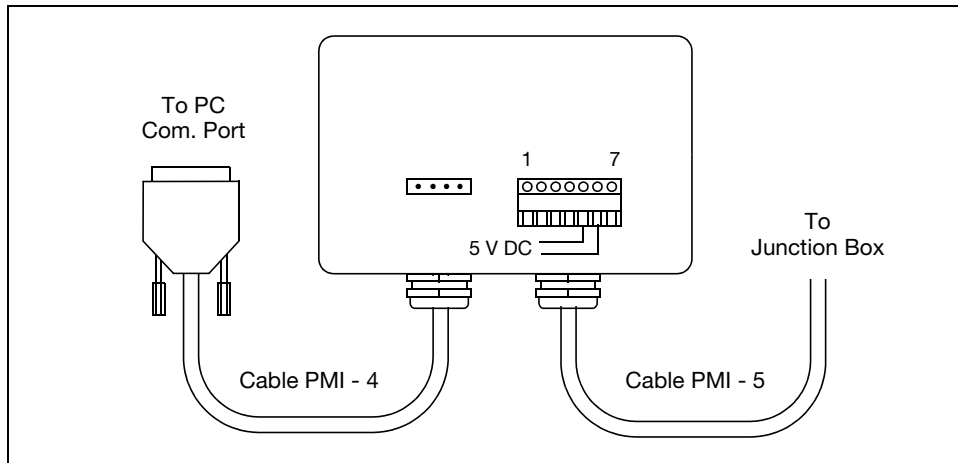

Fig. A-12 Layout of the PMI System's Converter Box

PMI Controller Power On Indicator	Checks
'On'	Remove lid of Converter Box and check that there is 5 V DC between terminals no. 5 & 6. See Fig. A-12.
'On'	If 5 V is not present, check whether it is available between terminals no. 12 & 13 of the Junction Box. See Fig. A-11 .
'On'	If 5 V is present in Junction Box, check the cable PMI - 5 between the Junction Box and Converter as the connections are probably incorrect.
'On'	If 5 V is present in Converter Box, check the connections of cable PMI - 4 between the Converter Box and PC.

Table A-2 Converter Box – Supply and Cable Checks

2. Try restarting measurement again and if it fails, check the status of the green 'Power On' light of the PMI Controller.
3. If the 'Power On' indicator is not lit, remove the lid of the Junction Box to which the PMI Controller is connected and note the status of the indicator lights on the printed circuit board in the box. See [Fig. A-11](#).
4. Make the cable connection, fuse and supply checks indicated in [Table A-1](#), according to the status of the indicator lights shown above.
5. If the 'Power On' indicator is lit, remove the lid of the Converter Box and perform the cable and power supply checks indicated in [Table A-2](#).

Erroneous Measurements:

In the following, examples are given about different types of erroneous measurement with hints on how to correct them.

p_i indication too high or p_{max} and p_{comp} too low:

The indicator cocks of the cylinders in question are probably defective and should be repaired or replaced.

Negative p_i and power indication:

No '0-diagram' has been chosen or the '0-diagram' selected is not a proper '0-Diagram' measurement without fuel injection. See Fig. A-13.

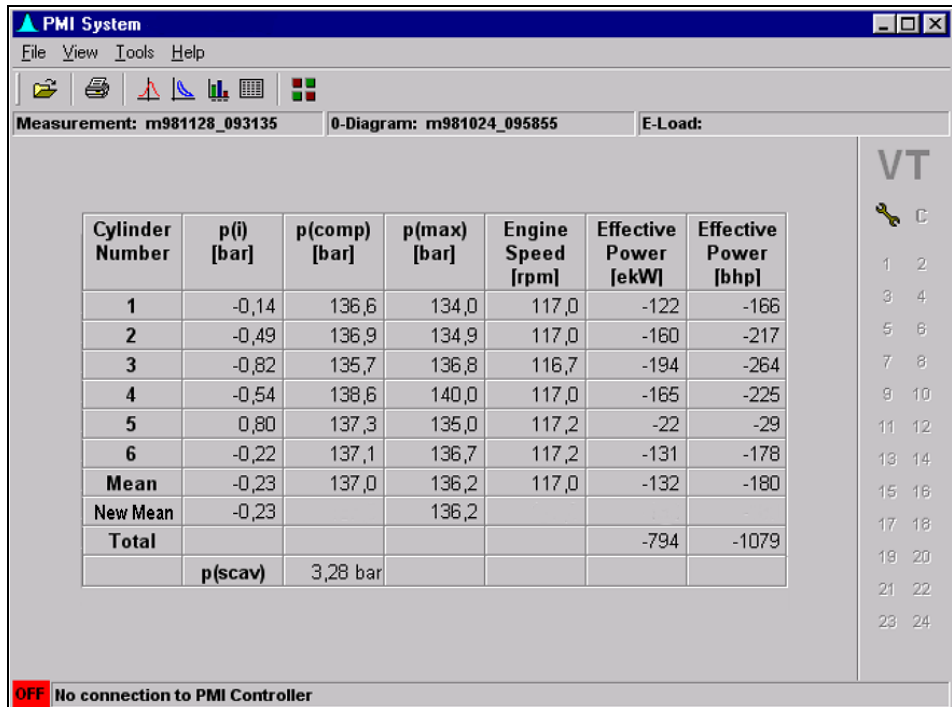

Fig. A-13 Erroneous measurement with negative p_i and power

TDC indication does not match earlier measurements:

The pickup has been moved after the '0-Diagram' was measured. Check the trigger system as in [section A.5.1](#).

Flat line in pressure diagram:

The indicator cock has not been opened or the PMI Controller and/or transducer are not functioning correctly and should be checked and possibly replaced. See [Fig. A-14](#).

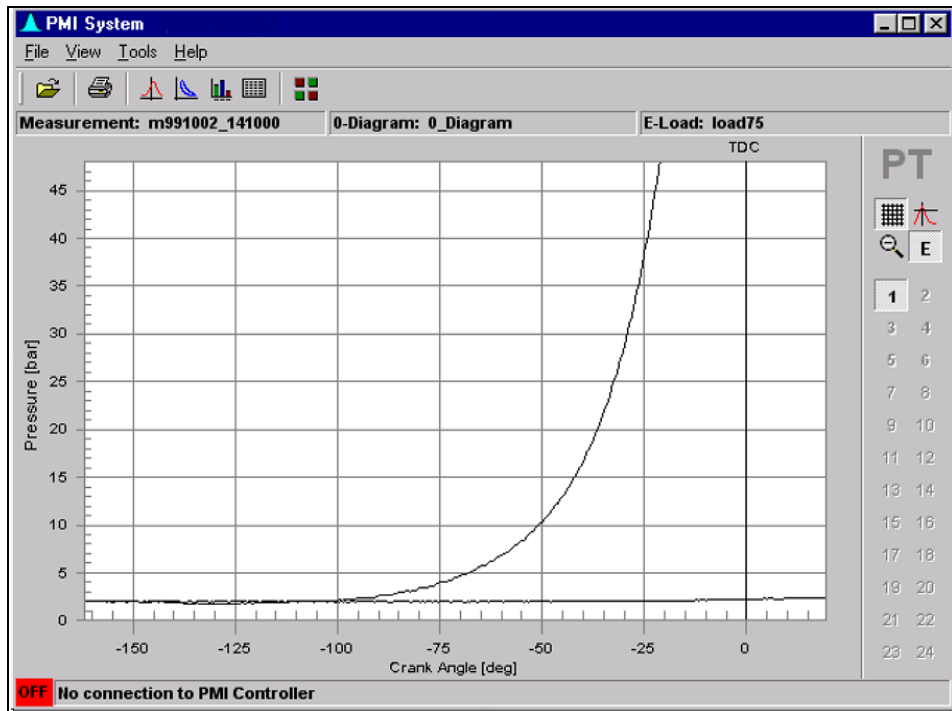

Fig. A-14 Erroneous measurement containing flat line

A.7 Technical Assistance

If you experience difficulties in using the PMI System, first carrying out the system and maintenance checks given in [section A.4](#) and [A.5](#) of this Appendix to see whether you can correct the problem. Additional, help is also available in [section A.6](#) and in the separate Mounting and Installation Guides which are provided.

If you cannot find the answer, you are welcome to contact MAN B&W Diesel A/S, whose address and phone number are given on the back cover of this Guide.

When you call by phone, you should have the PMI System documentation at hand and be prepared to give the following information:

- The name of the vessel or plant.
- The version and build number of your PMI System indicated under 'About' in the 'Help' menu.
- The operating system and type of hardware that you are using.
- A brief account of what happened and what you were doing when the problem occurred.
- The exact wording of any messages that appeared on your screen.
- Details about how you tried to solve the problem.

When you mail us, we ask you to include the above information, plus any relevant computer printouts which might be helpful.

Glossary

Glossary of Terms

Angle Encoder:

A precision instrument which generates a continuous train of electrical pulses for triggering the PMI System in accordance with the rotation and angular position of the crankshaft of an engine.

Balance Plot:

A histogram displaying balance values, e.g. cylinder pressure data, etc.

BDC – Bottom Dead Centre:

The lower most position of the piston.

Bore:

The diameter of the cylinder. Units: metre.

Calculated Values:

Values derived on the basis of PMI System measurements, e.g. effective engine power, pressure deviations and proposed adjustments.

Compression Pressure:

The pressure developed in a cylinder at TDC. Units: bar

Connecting Rod:

The rod coupling the piston with the crankshaft. The length of the rod is defined as the distance between the centres of the bores at either end of the rod. Units: metre.

Crank Angle:

The angle in degrees turned by the crankshaft.

Crank Angle Data:

Preset 'Edit Engine Data' defining the crank angle and firing properties of an engine selected with the 'Open Engine' command in the 'File' menu. The data can be viewed using the 'Open Engine' – 'Edit' function. The properties indicated are:

Crank Angle: The angular position of the start and end of the search band for the TDC's of the respective cylinders of the engine.

As rule of thumb, the end position lies $((360 / 2 * \text{number of cylinders}) + \text{five})$ degrees after the nominal position of the cylinder's TDC.

Firing Order: The sequence in which the respective cylinders of the engine fire.

Effective Power:

The power developed by an engine minus the power loss due to friction, etc. Units: ekW or bhp.

E-Load:

Pressure diagram based on pressure measurements on each cylinder taken under stable conditions at an engine load of 50 to 75%, equally distributed on all cylinders.

The E-Load diagram is used for torsion correction when determining the TDC of each cylinder.

Engine Name / Type / Address Data:

'Edit Engine Data' identifying the name, type and communication address of an engine selected with the 'Open Engine' command in the 'File' menu. Whereas the engine type is preset, the engine name and address can be changed using the 'Open Engine' – 'Edit' function.

Engine Properties:

Preset 'Edit Engine Data' defining the general properties of an engine selected with the 'Open Engine' command in the 'File' menu. The data can be viewed using the 'Open Engine' – 'Edit' function and lists the following properties:

Bore: The diameter of the engine cylinders. Units: metre.

Stroke: The length of travel of the piston. Units: metre.

Connecting Rod: The distance between the centres of the cross pin and crank bearings at either end of the rod. Units: metre.

$K_{pcomp/pscav}$: The ratio of cylinder compression and scavenge air pressure.

P_{loss} : The mean pressure loss due to friction in the engine. Units: bar.

Engine Speed:

The rotation velocity of the crankshaft, expressed in revolutions per minute. Units: rpm.

Firing Order:

The sequence in which the cylinders fire.

Index (Adjustment):

A value used to express the amount of fuel oil injected into an engine cylinder for adjusting the p_i .

LE-Pickup:

Light emitting sensor which detects the reflective stripes of a continuous strip of zebra tape on an engine crankshaft. Is used for triggering the PMI System in accordance with the rotation and angular position of the crankshaft of an engine.

MIP:

Abbreviated term referring to mean indicated pressure $p(i)$ or p_i

O-Diagram:

Pressure diagram based on pressure measurement on each cylinder taken at an engine load of 50 to 75% without fuel injection (hence without combustion) in the cylinder.

The 0-diagram is used when determining the TDC of each cylinder.

PD-Pickup:

Proximity detector which detects the teeth of a gear wheel or trigger ring on an engine. Is used for triggering the PMI System in accordance with the rotation and angular position of the crankshaft of an engine.

p(i) Adjustments:

Preset 'Edit Engine Data' defining the index adjustment properties of an engine selected with the 'Open Engine' command in the 'File' menu. The data can be viewed using the 'Open Engine' – 'Edit' function. The properties indicated are:

bar/Index: The change in mean indicated pressure [bars] caused by increasing or decreasing the fuel pump index by one index unit.

Turn/Index: The number of turns on the fuel pump index rod required to increase or decrease the fuel index by one index unit.

p(i) and p(max) Adjustment Limits:

Preset 'Edit Engine Data' defining the maximum pressure adjustment limits of a two stroke engine selected with the 'Open Engine' command in the 'File' menu. The data can be viewed using the 'Open Engine' – 'Edit' function. The properties indicated are:

p(i): The maximum acceptable positive or negative deviation in mean indicated pressure allowed between any two cylinders. Units: bar

p(max): The maximum acceptable positive or negative deviation in maximum pressure allowed between any two cylinders. Units: bar.

p(com)*p(scav)*: The maximum cylinder compression (measured as absolute values) expressed as a ratio. Is applicable for two stroke ME engines only.

p(max) Adjustments:

Preset 'Edit Engine Data' defining the index adjustment properties of a two stroke engine selected with the 'Open Engine' command in the 'File' menu. The data can be viewed using the 'Open Engine' – 'Edit' function. The properties indicated are:

bar/Shim or bar/Index: The change in maximum pressure caused by inserting or removing one shim or by increasing or decreasing the fuel index by one index unit.

Turn/Index: The number of turns on the VIT-Index rod required to increase or decrease the VIT-Index by one index unit.

Rotation of Link:

The number of turns required to obtain a certain displacement of the index rod.

PT Diagram:

Pressure vs. time diagram (draw diagram) showing the change in cylinder pressure as a function of the angular position of the cylinder from TDC.

PV Diagram:

Pressure volume diagram (indicator or working diagram, banana curve, etc.) showing the change in cylinder pressure as a function of the relative cylinder volume. The relative cylinder volume is 0% at TDC and 100% at BDC.

Reference Measurements:

User selectable engine data identifying which particular set of reference measurements (i.e. 0-Diagram and E-Load) that are to be used by default for correcting the TDC on all future pressure measurements on a specific engine.

All earlier measurements will continue to use the reference measurements that were previously selected as default, provided that they are not deleted.

For changing the current reference/default setting, select the 'Edit' function of the 'Open Engine' command in the 'File' menu.

Shim Adjustment:

The number of shims to be added or removed in a fuel pump for adjusting p_{\max} .

Stroke:

The length of travel of the piston from TDC to BDC. Units: metre.

Stroke – Engine Type:

The number of piston strokes during one work cycle of an engine.

Stroke and Index Type Info.:

Preset 'Edit Engine Data' defining the number of strokes of the piston during one work cycle and the method of p_{\max} cylinder pressure adjustment of an engine selected with the 'Open Engine' command in the 'File' menu. There is the choice of two or four stroke operation, fuel pump adjustments, etc.

The data can be viewed using the 'Open Engine' – 'Edit' function.

TDC – Top Dead Centre:

The upper most position of the piston.

Torsion:

The state of strain set up in a body by twisting or applying a torque.
Units: nRad/Nm.

Torsion Data:

Preset 'Edit Engine Data' defining the torsional deflection properties of an engine selected with the 'Open Engine' command in the 'File' menu. The data can be viewed using the 'Open Engine' – 'Edit' function. The properties indicated are:

Torsion Coefficient: The torsion coefficients of each section or group of sub sections of the crankshaft, starting from the fore end of the crankshaft to cylinder No. 1 (i.e. ->1), between cylinder No. 1 & 2 (i.e. 1->2), cylinder No. 2 & 3 (i.e. 2->3), cylinder No. 3 & 4 (i.e. 3->4) etc., up to the turning wheel (i.e. -> Turn). Units: nRad/Nm.

The values stated are fixed and are based on MAN B&W Diesel's own mechanical design and measurement criteria.

Trigger System Information:

User selectable 'Edit Engine Data' for selecting triggering according to the location ('Fore' or 'Aft') of the particular crankshaft pickups used on the engine. The data can be viewed using the 'Edit' function of the 'Open Engine' command in the 'File' menu.

If the triggering system is located at the drive end (normally aft) of the crankshaft, the following information is required:

- The diameter of the drive shaft. Units: metre
- The distance of the turning wheel to the triggering system. Units: metre.

VIT (Adjustment):

Variable Injection Timing. A method of controlling the timing of fuel oil injected into an engine cylinder for adjusting p_{\max} .

Work Cycle:

Two stroke engines: One work cycle is one full revolution of the crankshaft.

Four stroke engines: One work cycle is two full revolutions of the crankshaft.

Index

B	
Backing Up & Restoring Database	4 - 9
Balance Plots	3 - 12
C	
Calculated Values	3 - 14
Care & Handling of Equipment	A - 4
Checking Measurements	4 - 4
Commands	
About the PMI System	5 - 5
Backup	5 - 2
Balance Plot	5 - 3
Calculated Values	5 - 2, 5 - 3
Close Measurement	5 - 2
Communication	5 - 3
Communication Log	5 - 3
Contents	5 - 4
End Measurement	5 - 3
Exit	5 - 2
How to Use Help	5 - 5
Measuring Status	5 - 3
Open Engine	5 - 2
Open Measurement	5 - 2
Options	5 - 3
Print	5 - 2
Print Setup	5 - 2
PT Diagram	5 - 2
PV Diagram	5 - 3
Search for Help	5 - 5
Start Measurement	5 - 3
Test System	5 - 3
Communication Options	A - 6
Computer Requirements	A - 3
Crank Angle Sensors	2 - 4
D	
Deleting Measurements	4 - 8
Display Cursor	3 - 10
E	
Editing Measurements	4 - 4
Engine Address	A - 7
Erroneous Measurements	A - 20
Exploring	
Balance Plots	3 - 12
Calculated Values	3 - 14
PT Diagrams	3 - 8
PT Tool Panel	3 - 8
PV Diagrams	3 - 11
H	
Help	
Context Sensitive	5 - 5
Menu	5 - 4
M	
Main Window	3 - 2
Maintenance & Adjustments	
Angle Encoder	A - 11
LE-Pickup	A - 13
PD-Pickup	A - 15
Measurement Transducer	2 - 3
Measurements	
'0-Diagram'	2 - 8
'E-Load'	2 - 9
Cylinder Pressure	4 - 2
Menu Bar	3 - 2
Menus	
File	5 - 2

Help	5-4	S	
Quick-access	3-6	Status	
Tools	5-3	Line	3-4
View	5-2	Measurement	4-2
Mouse/keyboard Operation	3-4	System Checks	
O		Communication Options	A-6
Opening Engines	3-5	Default Settings	A-6
Opening Measurements	3-6	Engine Address	A-7
P		Storing Trigger Test Results	A-10
PMI Measurements	4-2	Triggering	A-8
PMI System		System Specification	A-2
Basic System	2-2	T	
Care & Handling	A-4	Technical Assistance	A-22
Conventions	1-4	Title Bar	3-2
Software Installation	A-3	Tool Panel	3-8
Starting the PMI System	3-2	Toolbar	3-3
Technical Specification	A-2	Trigger Test	A-8
Troubleshooting	A-16	Z	
What is the PMI System	2-2	Zoom Function	3-10
PT Diagrams	3-8		
PV Diagrams	3-11		
Q			
Quick-access Menu	3-6, 4-6		